

Catálogo

PRICE LIST
TARIF

2024

Fabricación de
herrajes para
carpintería metálica



Manufacture of fittings
for metallic carpentry



Fabrication de ferrues
pour portes industrielles
en enclos

facrisur^{SL}



- 03** **CORREDERA INFERIOR** **03/07** Ruedas / Wheel / Roue.
LOWER SLIDING DOOR **08** Carriles, Topes / Tracks, stoppers / Rail, arrêts.
COULISSE BAISSER **11** Caja poleas / Plate top / Plaque guide.
12 Cerradura, Rodillo, Maneta / Lock, Roller, Handle / Serrure, Coussinet, Poignée.
- 12** **CORREDERA SUPERIOR** **13** Roldanas / Trolley / Charriot.
TOP SLIDING DOOR **14** Rail para Roldanas / Rail for trolleys / Rail pour chariots.
COULISSE SUPÉRIEURE **13** Abrazadera para Railes / Rail support / Support pour rails.
14 Rail Inferior / Bottom track / Guide inférieur.
14 Rodillo Guiador Inferior / Bottom guide / Guide inférieur.
12 Maneta regulables / Handle / Poignee
14 Topes para railes / Stopper for rails / Arrêt pour rails.
- 15** **CANCELAS** **15** Punto de Giro / Pivot spin / Pivot avec.
STEEL GATES **16/17** Cerrojos / Bolt / Verrau.
PORTAILS **18/19** Bisagras / Hinge / Charnière.
20 Pernios, Pernos / Flag hinge, Flag / Paumelle.
21 Pernos, Pasadores / Flag, Squared barrel / Paumelle, Verrou carré avec.
22/26 Pasadores / Squared barrel / Verrou carré avec.
- 27** **PUERTAS BASCULANTES** **27** Polea / pulley / poulie.
OVERHEAD DOORS **28** Bisagra angulo superior. / Hinge for upper angle / Charnière pour angle supérieur.
PORTES BASCULANTES **28** Anticaídas p. Basculantes, / Safety brakes / Freins de sécurité.
- 28** **VARIOS** **28** Protector bombillo / Protection cylinder / Protection trou de serrure.
VARIOUS **29** Tirador / Floding handle / Poignée á abatants.
VARIÉ **30** Roseta / Rose / Rosette.
30 Tirador persiana / Blind puller / Poignée store.
30 Cerrojo cola de ratón / Bolt with mouse tail and bridge / Verrou avec la queue de la souris et pont.
31 Punta de lanza / Top of lance / Pointe de lance.
31 Pestillera para cerrojo / Hole bolt / Trou verrou.
31 Rinconera para junquillo / Corner glazing bead / Encoignure pour jonquille.
- 32** **ACERO INOXIDABLE** **32** Rueda canal / Groove wheel / Roue cannelure.
STAINLESS STEEL **32/33** Rueda canal ángulo / Groove wheel box / Roue avec support.
ACIER INOXYDABLE **34** Rueda nylon / Nylon wheel / Nylon avec.
34 Polea canal / Groove wheel / Roue cannelure.
35 Rodillo nylon / Nylon roller / Poulie guide en nylon.
35 Caja poleas guía regulable / Plate top guide / Plaque guide.
35 Bisagra fija esférica / Spherica hinge / Paumelle esferica.
36 Pernio pala / Flag hinge / Paumelle á pelle.
36/37 Pasador cuadrado / Deadbolt squared / Verrou carré avec.
38 Bisagra libro / Butt hinge / Charnière livre.
38 Perno torneado / Hinge / Paumelle.

RUEDA CANAL 20/16 m/m

20/16 mm Groove wheel
Roue cannelure 20/16 m/mm

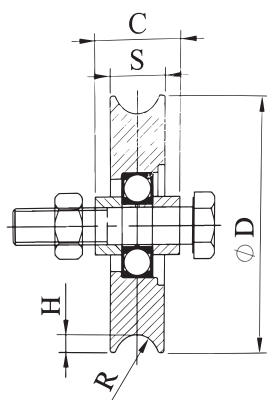

REFERENCIA	Ø	C	H	S	R	kg	📦	€/UD.
R16R060T	60	33	9	23	16	400	24	8,063 €
R16R080T	80	33	9	23	16	600	24	8,454 €
R16R090T	90	33	9	23	16	600	24	10,289 €
R16R100T	100	33	9	23	16	600	24	9,904 €
RER060T	60	33	9	23	20	400	24	8,063 €
RER080T	80	33	9	23	20	600	24	8,454 €
RER090T	90	33	9	23	20	600	24	10,289 €
RER100T	100	33	9	23	20	600	24	9,904 €
RER120T	120	33	9	23	20	600	12	12,575 €
RER140T	140	33	9	23	20	720	12	15,569 €
RER150T	150	33	9	23	20	720	12	23,332 €

REFERENCIA	Ø	C	H	S	kg	📦	€/UD.
REV060T	60	33	8	23	400	24	8,063 €
REV080T	80	33	8	23	600	24	8,454 €
REV090T	90	33	8	23	600	24	10,289 €
REV100T	100	33	8	23	600	24	9,904 €
REV120T	120	33	8	23	600	12	12,575 €
REV140T	140	33	8	23	720	12	15,569 €
REV150T	150	33	8	23	720	12	23,332 €

RUEDA CANAL ÁNGULO "V"

V groove wheel
Roue cannelure V

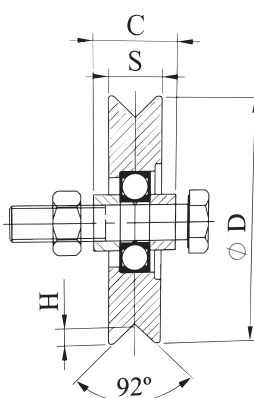

RUEDA CANAL 20m/m DOBLE RODAMIENTO

20 mm double bearing Groove wheel
Roue cannelure double 20 mm

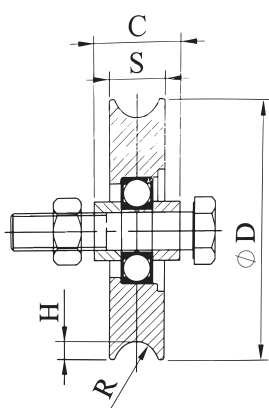

REFERENCIA	Ø	C	H	S	R	kg	📦	€/UD.
RER080DR	80	45	9	30	20	1.400	10	22,060 €
RER100DR	100	45	9	30	20	1.400	10	27,006 €
RER120DR	120	45	9	30	20	1.400	10	31,128 €
RER140DR	140	45	9	30	20	1.400	6	33,937 €
RER150DR	150	45	9	30	20	1.400	6	34,704 €
RER180DR	180	45	9	30	20	1.400	4	50,324 €
RER200DR	200	45	9	30	20	1.400	2	55,557 €

REFERENCIA	Ø	C	H	S	kg	📦	€/UD.
REV080DR	80	45	8	30	1.400	10	22,060 €
REV100DR	100	45	8	30	1.400	10	27,006 €
REV120DR	120	45	8	30	1.400	10	31,128 €
REV140DR	140	45	8	30	1.400	6	33,937 €
REV150DR	150	45	8	30	1.400	6	34,704 €
REV180DR	180	45	8	30	1.400	4	50,324 €
REV200DR	200	45	8	30	1.400	2	55,557 €

RUEDA CANAL ÁNGULO "V" DOBLE RODAMIENTO

NEW

V double bearing groove wheel
Roue cannelure double V

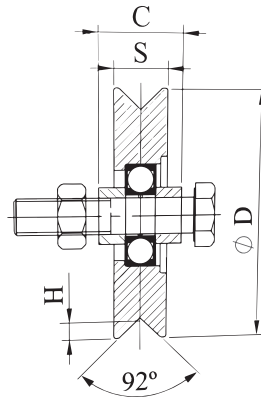

RUEDA CANAL 20/16 m/m SOLDAR

20/16 mm Groove wheel box to weld
Roue cannelure 20/16 m/mm avec support à souder

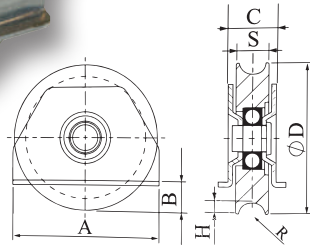
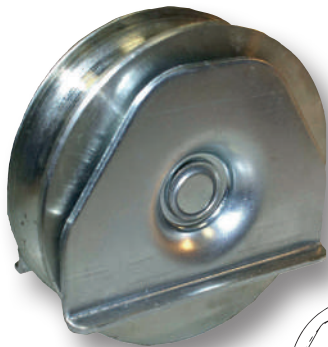

REFERENCIA	Ø	C	H	S	R	A	B	kg	📦	€/UD.
R16R060S	60	33	9	23	16	62	10	400	24	8,462 €
R16R080S	80	33	9	23	16	90	11	600	24	12,434 €
R16R090S	90	33	9	23	16	90	17	600	24	13,967 €
R16R100S	100	33	9	23	16	90	22	600	24	13,854 €
RER060S	60	33	9	23	20	62	10	400	24	8,462 €
RER080S	80	33	9	23	20	90	11	600	24	12,434 €
RER090S	90	33	9	23	20	90	17	600	24	13,967 €
RER100S	100	33	9	23	20	90	22	600	24	13,854 €
RER120S	120	33	9	23	20	130	15	600	12	16,729 €
RER140S	140	33	9	23	20	130	23	720	12	23,701 €

REFERENCIA	Ø	C	H	S	R	kg	📦	€/UD.
RER080DRS	80	45	9	30	20	1.400	10	25,652 €
RER100DRS	100	45	9	30	20	1.400	10	30,720 €
RER120DRS	120	45	9	30	20	1.400	10	37,350 €
RER140DRS	140	45	9	30	20	1.400	6	40,520 €

RUEDA CANAL 20 m/m DOBLE RODAMIENTO SOLDAR

NEW

20 m/m double bearing groove to weld
Roue cannelure double 20 m/m avec support à souder

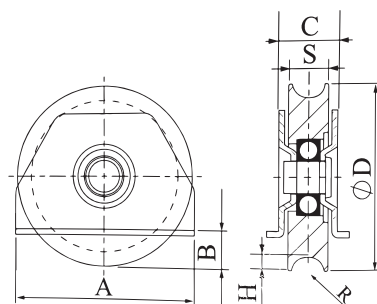

RUEDA CANAL ANGULO "V" SOLDAR

V Groove wheel box to weld
Roue V avec support à souder

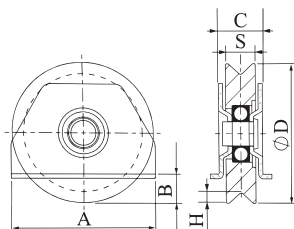

REFERENCIA	Ø	C	H	S	A	B	kg	📦	€/UD.
REV060S	60	33	8	23	62	10	400	24	8,462€
REV080S	80	33	8	23	90	11	600	24	12,434 €
REV090S	90	33	8	23	90	17	600	24	13,967 €
REV100S	100	33	8	23	90	22	600	24	13,854 €
REV120S	120	33	8	23	130	15	600	12	16,729 €
REV140S	140	33	8	23	130	23	720	12	23,701 €

REFERENCIA	Ø	C	H	S	kg	📦	€/UD.
REV080DRS	80	45	8	30	1.400	10	25,652 €
REV100DRS	100	45	8	30	1.400	10	30,720 €
REV120DRS	120	45	8	30	1.400	10	37,350 €
REV140DRS	140	45	8	30	1.400	6	40,520 €

RUEDA CANAL ANGULO "V" DOBLE RODAMIENTO SOLDAR

20 mm double bearing groove to weld
Roue cannelure double 20 mm avec support à souder

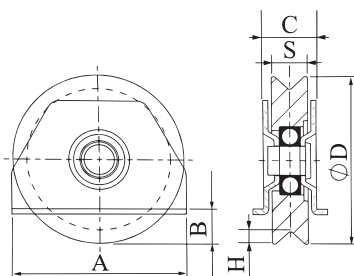

RUEDA CANAL 20/16 m/m ATORNILLAR

20/16 mm Groove wheel box to fit
Roue cannelure 20/16 m/mm fit support à encastrer

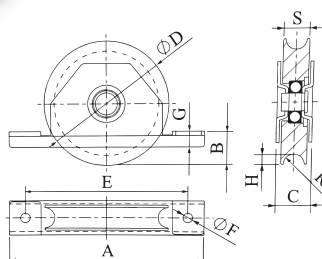

REFERENCIA	Ø	C	H	S	R	A	B	E	ØF	G	kg	📦	€/UD.
R16R080	80	33	9	23	16	150	30	125	9	15	600	24	12,434 €
R16R090	90	33	9	23	16	150	35	125	9	15	600	24	13,967€
R16R100	100	33	9	23	16	150	40	125	9	15	600	24	13,854 €
RER080	80	33	9	23	20	150	30	125	9	15	600	24	12,434 €
RER090	90	33	9	23	20	150	35	125	9	15	600	24	13,967 €
RER100	100	33	9	23	20	150	40	125	9	15	600	24	13,854 €
RER120	120	33	9	23	20	200	40	180	9	20	600	12	16,729 €
RER140	140	33	9	23	20	200	50	180	9	20	720	12	23,701 €

REFERENCIA	Ø	C	H	S	A	B	E	ØF	G			€/UD.
REV080	80	33	8	23	150	30	125	9	15	600	24	12,434 €
REV090	90	33	8	23	150	35	125	9	15	600	24	13,967 €
REV100	100	33	8	23	150	40	125	9	15	600	24	13,854 €
REV120	120	33	8	23	200	40	180	9	20	600	12	16,729 €
REV140	140	33	8	23	200	50	180	9	20	720	12	23,701 €

RUEDA CANAL ANGULO "V" ATORNILLAR

V Groove wheel box to fit
Roue c. V avec support à encastrer

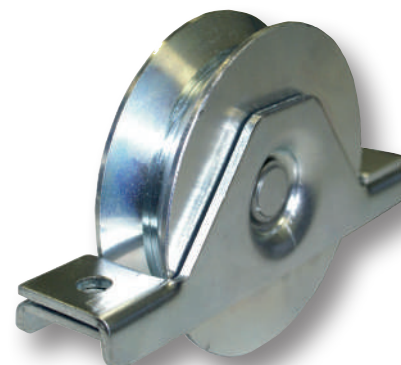
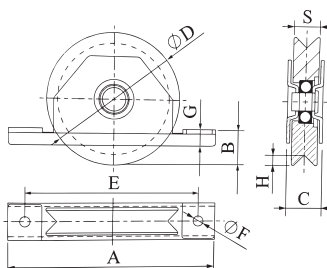

RUEDA NYLON CANAL 20/16 mm ATORNILLAR

20/16 mm nylon wheel with box to fit
R.20/16 nylon avec support à encastrer

REFERENCIA	Ø	C	H	S	R	A	B	E	ØF	G			€/UD.
RER080N	80	33	9	23	20	150	30	125	9	15	600	12	11,784 €
RER100N	100	33	9	23	20	150	40	125	9	15	600	12	15,375 €
RER120N	120	33	9	23	20	200	40	180	9	20	600	12	17,738 €
RER080N16	80	33	9	23	16	150	30	125	9	15	600	12	11,784 €
RER100N16	100	33	9	23	16	150	40	125	9	15	600	12	15,375 €
RER120N16	120	33	9	23	16	200	40	180	9	20	600	12	17,738 €

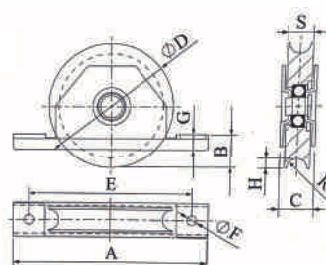
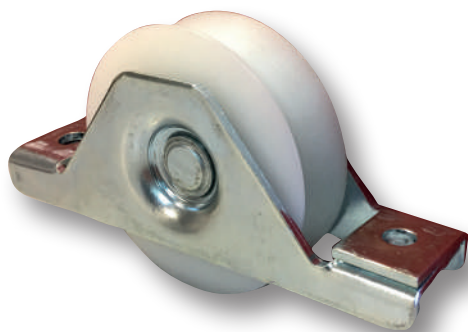

REFERENCIA	Ø	C	H	S	A	B	E	ØF	G			€/UD.
REV080N	80	33	8	23	150	30	125	9	15	600	12	11,784 €
REV100N	100	33	8	23	150	40	125	9	15	600	12	15,375 €
REV120N	120	33	8	23	200	40	180	9	20	600	12	17,738 €

RUEDA NYLON CANAL ÁNGULO "V" ATORNILLAR

V nylon wheel with box to fit
R.V nylon avec support à encastrer

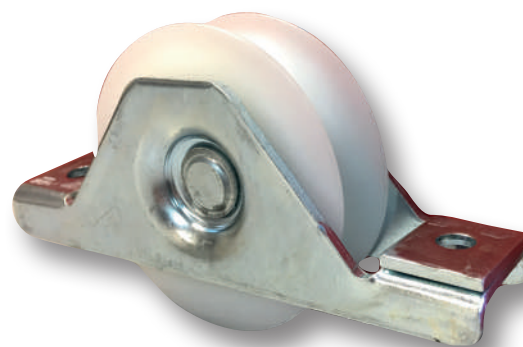
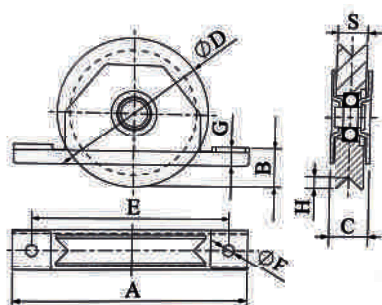

RUEDA NYLON CANAL 20/16 m/m

20/16 Groove nylon wheel
Roue nylon 20/16 m/m

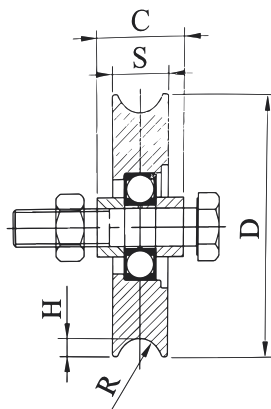

REFERENCIA	Ø	C	H	S	R	kg	paq	€/UD.
R16R060TN	60	33	9	23	16	400	24	8,219 €
R16R080TN	80	33	9	23	16	600	24	8,617 €
R16R090TN	90	33	9	23	16	600	24	10,488 €
R16R100TN	100	33	9	23	16	600	24	10,096 €
RER060TN	60	33	9	23	20	400	24	8,219 €
RER080TN	80	33	9	23	20	600	24	8,617 €
RER090TN	90	33	9	23	20	600	24	10,488 €
RER100TN	100	33	9	23	20	600	24	10,096 €
RER120TN	120	33	9	23	20	600	12	12,819 €
RER140TN	140	33	9	23	20	720	12	15,872 €

REFERENCIA	Ø	C	H	S	kg	paq	€/UD.
REV060TN	60	33	8	23	400	24	8,219 €
REV080TN	80	33	8	23	600	24	8,617 €
REV090TN	90	33	8	23	600	24	10,488 €
REV100TN	100	33	8	23	600	24	10,096 €
REV120TN	120	33	8	23	600	12	12,819 €
REV140TN	140	33	8	23	720	12	15,872 €

RUEDA NYLON CANAL ÁNGULO "V"

V nylon groove wheel
Roue nylon cannelure V

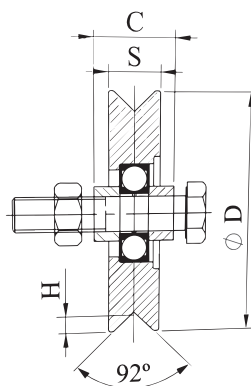

RUEDA CANAL 20/16 m/m SOBREPONER

20/16 m/m G. wheel box to superimpose
Roue c. 20/16 mm avec support à esterieur

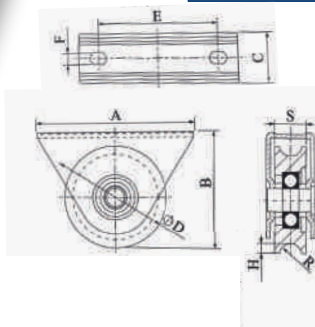
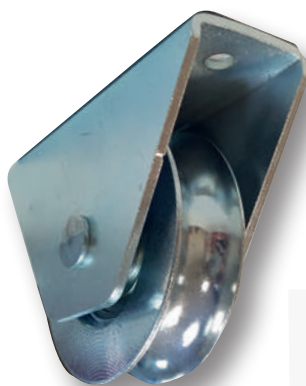

REFERENCIA	Ø	C	H	S	R	A	B	E	ØF	kg	paq	€/UD.
R16R080SP	80	40	9	23	16	120	86	90	9	600	12	14,425 €
R16R090SP	90	40	9	23	16	140	102	114	9	600	12	15,650 €
R16R100SP	100	40	9	23	16	140	108	114	9	600	12	15,561 €
RER080SP	80	40	9	23	20	120	86	90	9	600	12	14,425 €
RER090SP	90	40	9	23	20	140	102	114	9	600	12	15,650 €
RER100SP	100	40	9	23	20	140	108	114	9	600	12	15,561 €
RER120SP	120	40	9	23	20	140	130	114	9	600	12	17,324 €
RER140SP	140	40	9	23	20	140	150	114	9	720	12	23,309 €

REFERENCIA	Ø	C	H	S	A	B	E	ØF	📦	📦	€/UD.
REV080SP	80	40	8	23	120	86	90	9	600	12	14,425 €
REV090SP	90	40	8	23	140	102	114	9	600	12	15,650 €
REV100SP	100	40	8	23	140	108	114	9	600	12	15,561 €
REV120SP	120	40	8	23	140	130	114	9	600	12	17,324 €
REV140SP	140	40	8	23	140	150	114	9	720	12	23,309 €

RUEDA CANAL ÁNGULO "V" SOBREPONER

V.g. wheel box to superimpose
Roue c.v avec support à extérieur

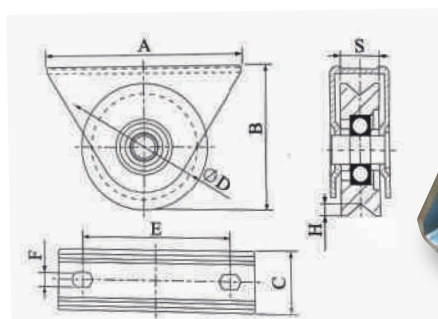

RUEDA CANAL 20 m/m GIRATORIA

20 m/m groove pivot wheel
Roue tournante cannelure 20 m/m

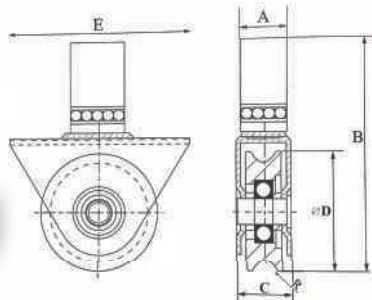
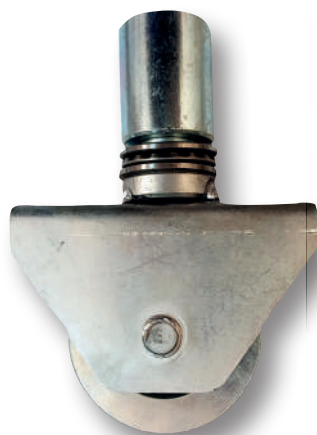

REFERENCIA	Ø	C	B	R	A	E	📦	📦	€/UD.
R16R080G	80	40	157	16	40	120	600	12	26,741 €
R16R090G	90	40	173	16	40	140	600	12	28,214 €
R16R100G	100	40	178	16	40	140	600	12	29,448 €
RER080G	80	40	157	20	40	120	600	12	26,741 €
RER090G	90	40	173	20	40	140	600	12	28,214 €
RER100G	100	40	178	20	40	140	600	12	29,448 €
RER120G	120	40	203	20	40	140	600	6	33,381 €
RER140G	140	40	213	20	40	140	720	6	37,036 €

CARRIL ATORNILLAR

Track to screw
Rail á visser

REFERENCIA	A	B	C	D	LARGO	€/UD.
CR20A	16	56	3	20	3 mt	39,047 €

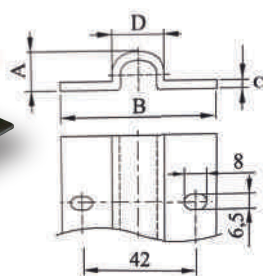
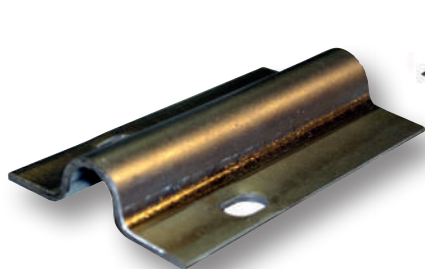

CARRIL EMPOTRAR

Track to fit
Rail á encastre

REFERENCIA	A	B	C	D	LARGO	€/UD.
CR20E	3	40	64	20	3 mt	51,609 €

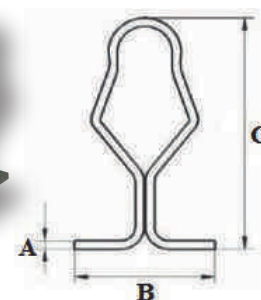
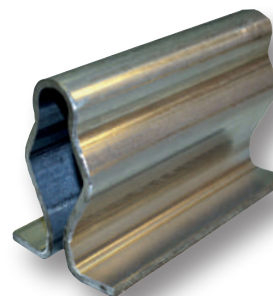

TOPE PUERTA CORREDERA

Stopper for sliding doors
Arrêt pour portes coulissantes

REFERENCIA	MED. /DIMENS.	📦	€/UD.
TPCA	125x70 Atornillar / Screw / Visser	12	14,019 €
TPCS	105x70 Soldar / Weld / Souder	12	8,051 €

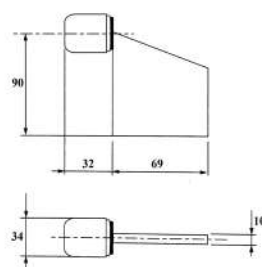
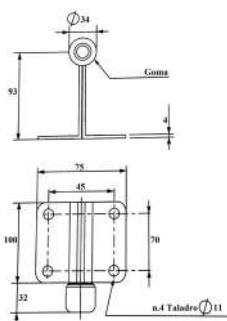
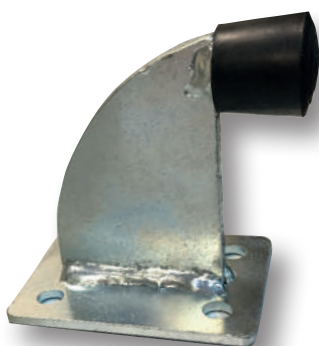

RODILLO NYLON

Nylon roller
Poulie guide en nylon

REFERENCIA	A	D	L	M	N	📦	€/UD.
RG0030	40	30	84	14	45	30	3,023 €
RG0040	40	40	84	14	45	30	3,474 €
RG0060	60	40	94	14	35	30	4,460 €
RG0035	50	35	94	14	45	30	3,250 €
RG0050	60	50	105	14	35	30	5,568 €
RG3535	35	35	78	14	45	30	3,249 €

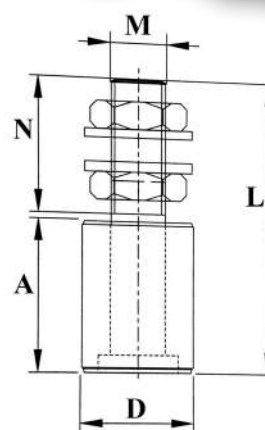

RODILLO NYLON EXTRA LARGO

Extra Long Nylon roller
Poulie guide en nylon Extra Long



REFERENCIA	MED. /DIMENS.	📦	€/UD.
RG0150	35X150 M. 16	6	27,980 €
RG0250	35X250 M. 16	6	43,050 €

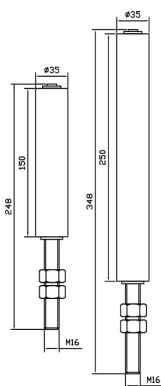

CAJA POLEAS GUÍA REGULABLE

Plate top guide
Plaque guide

REFERENCIA	MED. /DIMENS.	A	B	C	D	E	F	L	S	📦	€/UD.
CP0030S	Simple	70	140	50	-	30	70	155	3	10	15,273 €
CP0030M	Mediana	155	140	50	-	30	70	220	3	10	17,621 €
CP0030G	Grande	215	200	60	-	30	110	280	3	6	39,144 €
CP0030SG	Gigante	260	210	70	-	40	100	330	4	4	57,532 €
CP0030MP	Para pared	160	145	55	100	30	65	220	3	4	19,888 €

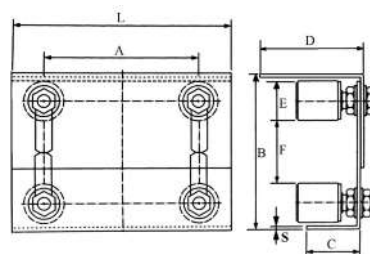
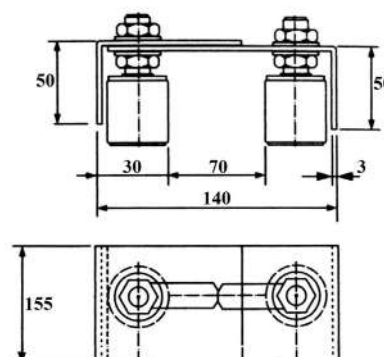
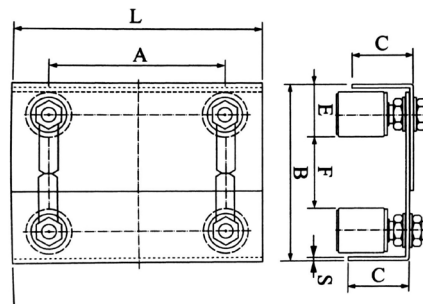

CORREDERA INFERIOR / LOWER SLIDING DOOR / COULISSE BAISSER



CERRADURA, RODILLO / LOCK, ROLLER / SERRURE, COUSSINET

CERRADURA DE GANCHO

	REF.	MED. / DIMENS.	📦	€/UD.
Hook lock	335	30 mm	1	16,500 €
Serrure	365	60 mm	1	33,653 €

CAJA PARA CERRADURA

	REF.	MED. / DIMENS.	📦	€/UD.
Cover box for lock	326	60 mm	1	8,798 €
Couverture pour serrure				

NEW

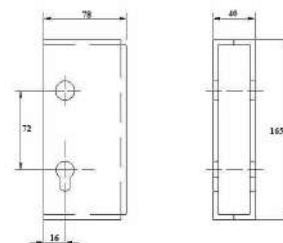

RODILLO GUÍA PUERTA CORREDERA

Guide roller sliding doors
Coussinet guide portes coulissantes

REFERENCIA	DESCRIPCIÓN	A	B	MÉTRICA	📦	€/UD.
U50M20	U50	40	10	20	12	7,815 €
U60M20	U60	52	15	20	12	8,336 €

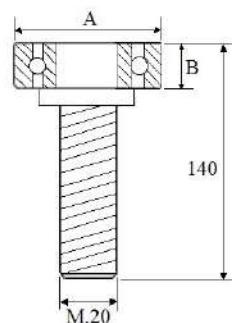

MANETAS REGULABLES / REGULATING HANDLE / POIGNÉE RÉGLABLE



MANETA/ HANDLE / POIGNÉE

REFERENCIA	A	B	📦	€/UD.
M62535	25x35	106	10	3,647 €
M64050	40x50	106	10	3,647 €
M65060	50x60	106	10	4,862 €

MANETA REGULABLE

Regulating handle
Poignée réglable

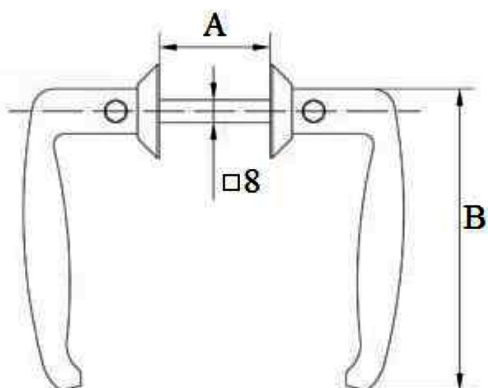

ROLDANA / TROLLEY / CHARRIOT

ROLDANA U-30

Trolley u-30
Chariot u-30



REFERENCIA	RUEDA	RESISTENCIA	📦	€/UD.
RCU30S	NYLON	75 Kg	15	6,690 €
RCU30D	NYLON	120 kg	15	10,880 €
RCU30SR	METAL	90 kg	15	7,418 €
RCU30DR	METAL	150 kg	15	11,961 €

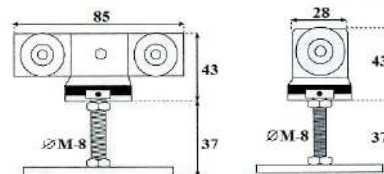

REFERENCIA	RUEDA	RESISTENCIA	📦	€/UD.
RCU40S	NYLON	70 Kg	30	6,858 €
RCU40D	NYLON	150 kg	30	11,368 €
RCU40SR	METAL	80 kg	30	7,310 €
RCU40DR	METAL	160 kg	30	11,709 €

ROLDANA U-40

Trolley u-40
Chariot u-40

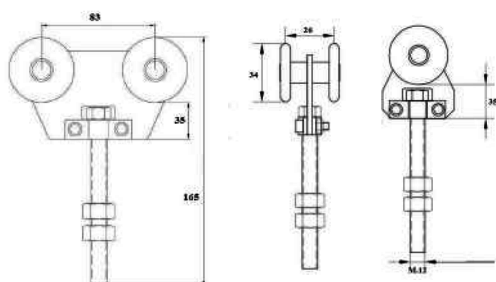

ROLDANA U-60

Trolley u-60
Chariot u-60



REFERENCIA	RUEDA	RESISTENCIA	📦	€/UD.
RCU60S	NYLON	100 Kg	30	8,433 €
RCU60D	NYLON	200 kg	30	13,081 €
RCU60SR	METAL	180 kg	30	10,723 €
RCU60DR	METAL	320 kg	30	17,196 €
RCU60DR900	METAL	900 kg	10	23,520 €

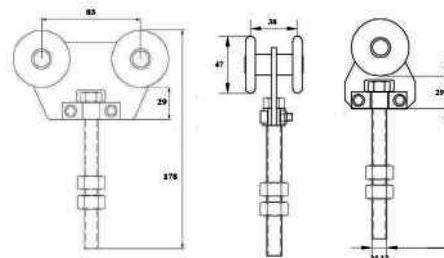

TOPE PARA RAILES

Stopper for rails
Arrêt pour rails



REFERENCIA	ACABADO	📦	€/UD.
TRCU30	GALVANIZADO	10	2,837 €
TRCU40	GALVANIZADO	10	3,080 €
TRCU60	GALVANIZADO	10	5,079 €

RAIL / RAIL / RAIL

REFERENCIA	BASE X ALTURA	ESPESOR	LONGITUD	ACABADO	3M €/UD.	6M €/UD.
RLRCU30A	30x33 ATORNILLAR	2	3/6 M	GALVANIZADO	22,162 €	44,325 €
RLRCU30S	30x33 SOLDAR	2	3/6 M	GALVANIZADO	24,953 €	49,905 €
RLRCU40	40x40 SOLDAR	1,5	3/6 M	GALVANIZADO	22,407 €	44,814 €
RLRCU60	60x55 SOLDAR	2,5	3/6 M	GALVANIZADO	51,582 €	103,166 €

RAIL PARA ROLDANAS

Rail for trolleys
Rail pour chariots

NEW

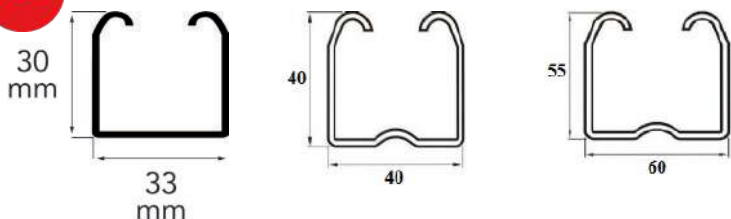

ABRAZADERA PARA RAILES

Rail support
Support pour rails

REFERENCIA	ACABADO	📦	€/UD.
EMRCU40	GALVANIZADO	10	8,966 €
EMRCU60	GALVANIZADO	10	9,814 €



RAIL CURVA SUPERIOR

Upper curve rail
Rail de courbe supérieure

REFERENCIA	ESPESOR	GRADOS	ACABADO	€/UD.
CSU40	1,5	90	GALVANIZADO	111,92 €
CSU60	2,5	90	GALVANIZADO	114,21 €



RODILLO GUIADOR INFERIOR U-19 NYLON

U-19 bottom guide
Guide inférieur U-19

REFERENCIA	📦	€/UD.
REIV19	10 V/€	7,85 €

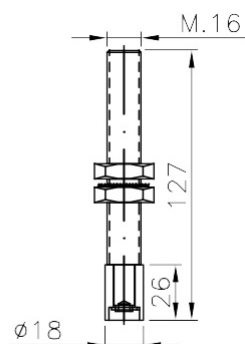

RAIL INFERIOR GUIADOR U-19

Bottom track U-19
Rail inférieur U-19

REF.	ESPESOR	LONGITUD	ACABADO	3M/€UN/U	6M/€UN
RLRI19	3	3/6	GALVANIZADO	22,31€	44,68€

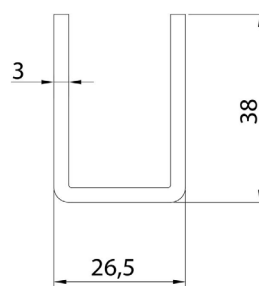

PUNTO DE GIRO 30/40MM

30/40mm pivot spin
Pivot avec bille 30/40mm

REFERENCIA	MEDIDAS	ØA	B	ØC	D	RESISTENCIA	ACABADO	📦	€/UD.
08001	40 mm Juego	40	60	40	53	200 kg	CINCADO	12	15,312 €
08001A	40 mm Superior	40	60			-	CINCADO	12	6,789 €
08001B	40 mm Inferior			40	53	200 Kg	CINCADO	12	7,986 €
08003	30 mm Juego	30	48	30	39	80 kg	CINCADO	12	11,150 €
08003A	30 mm Superior	30	48			-	CINCADO	12	4,807 €
08003B	30 mm Inferior			30	39	80 kg	CINCADO	12	7,241 €

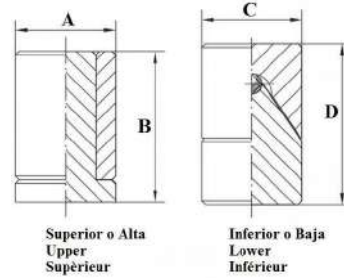

REFERENCIA	MEDIDAS	Ø	RESISTENCIA	ACABADO	📦	€/UD.
08042	42 mm Juego	42	750 kg	CINCADO	8	41,672 €
08042A	42 mm Superior	42	-	CINCADO	8	25,052 €
08042B	42 mm Inferior	42	750 kg	CINCADO	8	16,077 €

PUNTO DE GIRO 42 m/m RODAMIENTO

42mm Pivot spin with bearing
Pivot avec roulement 42mm

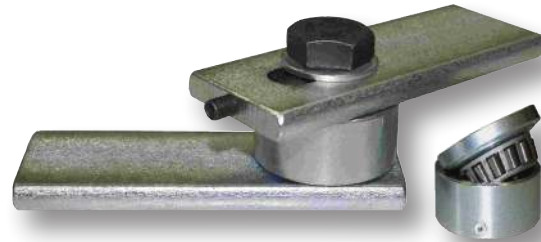
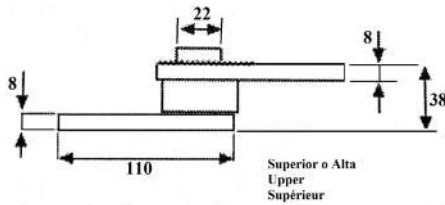

PUNTO DE GIRO 60/80/120 m/m RODAMIENTO

60/ 80/ 120 mm pivot spin with bearing
Pivot avec roulement 60/ 80/ 120 mm

REFERENCIA	MEDIDAS	Ø	RESISTENCIA	ACABADO	📦	€/UD.
08060	60 mm Juego	60	2500 kg	CINCADO	2	56,287 €
08060A	60 mm Superior	60	-	CINCADO	2	24,605 €
08060B	60 mm Inferior	60	2500 kg	CINCADO	2	31,683 €
08080	80 mm Juego	80	3700 kg	CINCADO	2	79,821 €
08080A	80 mm Superior	80	-	CINCADO	2	45,738 €
08080B	80 mm Inferior	80	3700 kg	CINCADO	2	34,913 €
08120	120 mm Juego	120	4.300 kg	CINCADO	-	176,80 €
08120A	120 mm Superior	120	-	CINCADO	-	90,80 €
08120B	120 mm Inferior	120	4.300 kg	CINCADO	-	86,00 €



CERROJO SOLDAR

Bolt to weld
Verrou á souder

- * con taladro para candado
- * with hole for lock
- * avec trou pour cadenas

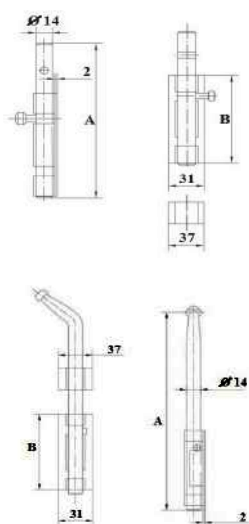

REFERENCIA	MEDIDAS	A	B	ACABADO	📦	€/UD.
*CSL070	70 mm	98	70	BICROMATADO	15	2,785€
*CSL085	85 mm	128	85	BICROMATADO	15	2,912 €
*CSL100	100 mm	158	100	BICROMATADO	15	3,180 €
*CSL120	120 mm	198	120	BICROMATADO	12	4,490 €
CSL200	200 mm	170	85	BICROMATADO	10	4,595 €
CSL250	250 mm	220	85	BICROMATADO	10	4,741 €
CSL300	300 mm	270	85	BICROMATADO	10	5,034 €
CSL400	400 mm	370	100	BICROMATADO	10	5,616 €
CSL500	500 mm	470	100	BICROMATADO	10	5,988 €
CSL600	600 mm	570	100	BICROMATADO	10	7,019€



CERROJO ATORNILLAR

Bolt to screw
Verrou á visser

- * con taladro para candado
- * with hole for lock
- * avec trou pour cadenas

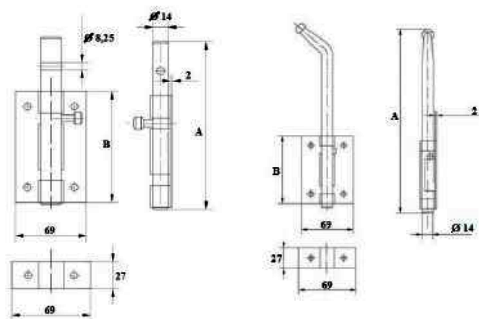

REFERENCIA	MEDIDAS	A	B	ACABADO	📦	€/UD.
*CAT070	70 mm	98	70	BICROMATADO	10	2,460 €
*CAT085	85 mm	128	85	BICROMATADO	10	2,786 €
*CAT100	100 mm	158	100	BICROMATADO	10	3,108 €
*CAT120	120 mm	198	120	BICROMATADO	10	4,349 €
CAT200	200 mm	170	85	BICROMATADO	10	4,495 €
CAT250	250 mm	220	85	BICROMATADO	10	4,689 €
CAT300	300 mm	270	85	BICROMATADO	10	4,702 €
CAT400	400 mm	370	100	BICROMATADO	10	5,276 €
CAT500	500 mm	470	100	BICROMATADO	10	5,808 €
CAT600	600 mm	570	100	BICROMATADO	10	6,652 €



REF. IZQ.	REF. DCHA.	TIPO	A	B	📦	€/UD.
07016CI	07016CD	SOLDAR	200	16	10	20,121 €
07025CI	07025CD	SOLDAR	250	16	10	21,535 €
07002CI	07002CD	SOLDAR	330	22	10	26,801 €
07004CI	07004CD	SOLDAR	500	22	6	37,730 €
07016ACI	07016ACD	ATORNILLAR	200	16	10	20,921 €
07025ACI	07025ACD	ATORNILLAR	250	16	10	22,792 €
07002ACI	07002ACD	ATORNILLAR	330	22	10	28,551 €
07004ACI	07004ACD	ATORNILLAR	500	22	6	39,961 €
IGUALAMIENTO CERROJOS						5,750 €

CERROJOS CANCELA CON LLAVE

Steel gate bolt with key
Verrou portails avec clé

NEW

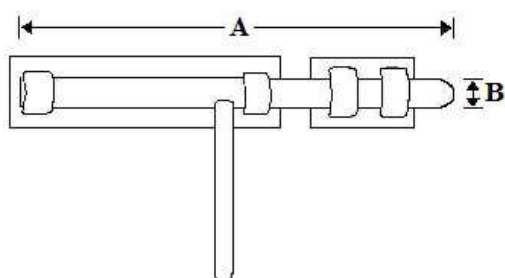

BOMBILLOS REPOSICIÓN PARA CERROJOS

Replacement cylinder for locks
Cylindre de remplacement pour serrures

NEW

REFERENCIA	📦	€/UD.
B3726	5	8,520 €



REFERENCIA	TIPO	A	B	ACABADO	📦	€/UD.
07016	SOLDAR	200	16	CINCADO	25	12,664 €
07025	SOLDAR	250	16	CINCADO	25	14,553 €
07002	SOLDAR	330	22	CINCADO	20	19,559 €
07004	SOLDAR	500	22	CINCADO	12	29,387 €
07016A	ATORNILLAR	200	16	CINCADO	25	13,394 €
07025A	ATORNILLAR	250	16	CINCADO	25	14,268 €
07002A	ATORNILLAR	330	22	CINCADO	20	20,382 €

CERROJO CANCELA SIN LLAVE

Steel gate bolt without key
Verrou portails sans clé

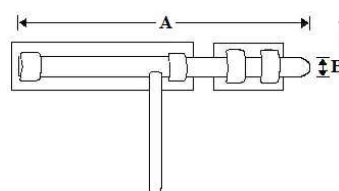

PERNO PALA

Flag hinge
Paumelle á pelle

REF. PULIDA	REF. CINCADA	ØD X A	E	B	C	ØF	PALA	📦	€/UD. PULIDA	€/UD. CINCADA
7013	7013G	10 x 60	2	28	10	6	MEDIA	100	0,376 €	0,449 €
7001	7001G	12 x 80	2	38	3	8	CORTA	100	0,456 €	0,547 €
7009	7009G	12 x 80	2	38	15	8	LARGA	80	0,474 €	0,566 €
7002	7002G	14 x 80	3	38	3	8	CORTA	100	0,434 €	0,519 €
7003	7003G	14 x 80	3	38	16	8	LARGA	75	0,534 €	0,639 €
7012	7012G	16 x 100	3	49	3	10	CORTA	60	0,657 €	0,789 €
7004	7004G	16 x 100	3	49	10	10	MEDIA	50	0,755 €	0,908 €
7004L	7004LG	16 x 100	3	49	25	10	LARGA	50	0,912 €	1,094 €
7005	7005G	18 x 110	4	53	13	10	MEDIA	40	0,999 €	1,140 €
7005L	7005LG	18 x 110	4	53	23	10	LARGA	50	1,139 €	1,421 €
7006	7006G	20 x 120	4	59	15	12	MEDIA	30	2,012 €	2,413 €
7006L	7006LG	20 x 120	4	59	23	12	LARGA	30	2,210 €	2,653 €
7008	7008G	25 x 120	5	56	13	14	MEDIA	24	3,059 €	3,669 €
7010	7010G	25 x 140	5	68	13	14	MEDIA	30	3,687 €	4,429 €
7007	7007G	30 x 150	6	72	7	15	CORTA	30	4,174 €	5,010 €
7007L	7007LG	30 x 150	6	72	25	15	LARGA	30	4,383 €	5,251 €
7006XL	7006XLG	20 x 120	4	59	42	12	LARGA	30	2,763 €	3,179 €

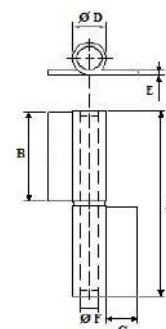

PERNO PALA CON RODAMIENTO

Flag hinge with bearing
Paumelle á pelle avec roulement

REF. PULIDA	REF. CINCADA	ØD X A	E	B	C	ØF	PALA	📦	€/UD. PULIDA	€/UD. CINCADA
7006R	7006RG	20 x 130	4	59	15	12	MEDIA	30	4,155 €	4,986 €
7006LR	7006LRG	20 x 130	4	59	23	12	LARGA	30	4,285 €	5,087 €
7007R	7007RG	30 x 160	6	72	7	15	CORTA	30	11,236 €	13,426 €
7007LR	7007LRG	30 x 160	6	72	25	15	LARGA	30	11,342 €	11,447 €
7010R	7010RG	25 x 150	5	68	13	14	LARGA	30	9,714 €	11,656 €

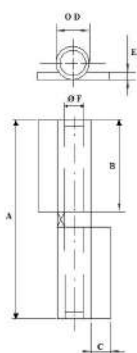

BISAGRA, HINGE, CHARNIÈRE

BISAGRA FIJA ESFÉRICA

	REF. PULIDA	REF. CINCADA	A	B	ØC	D	E	ØF	G	⊞	€/UD. PULIDA	€/UD. CINCADA
Spherica hinge	2001	2001G	38	80	10	95	2,5	16	39	75	1,451 €	1,670 €
Paumelle esferica	2002	2002G	48	100	10	95	2,5	16	39	75	1,718 €	1,976 €
	* 2004	* 2004G	38	119	10	95	2,5	16	39	50	3,085 €	3,342 €

* Tres cuerpos

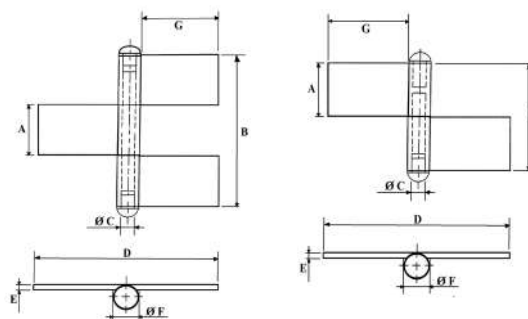
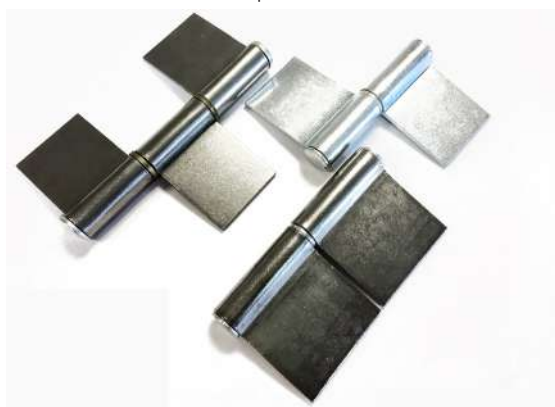

REF. PULIDA	REF. CINCADA	A	B	ØC	D	E		⊞	€/UD. PULIDA	€/UD. CINCADA
301P	3001	80	54	10	3	16		75	2,012 €	2,099 €
302P	3002	100	65	12	4	20		50	2,684€	2,973 €
303P	3003	120	65	12	4	20		50	2,965 €	3,080 €
301PD	3001D	80	54	10	3	16	DESMONTABLE	75	2,012 €	2,099 €
302PD	3002D	100	65	12	4	20	DESMONTABLE	50	2,684€	2,973 €
303PD	3003D	120	65	12	4	20	DESMONTABLE	50	2,965 €	3,080 €
301PT	3001T	80	54	10	3	16	TALADRADA	75	2,084 €	2,171 €
302PT	3002T	100	65	12	4	20	TALADRADA	50	2,705 €	3,039 €
303PT	3003T	120	65	12	4	20	TALADRADA	50	3,037 €	3,186 €

BISAGRA LIBRO

Butt hinge
Charnière livre

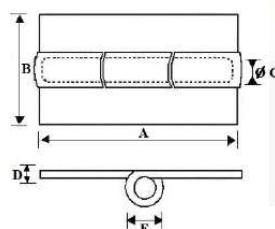

PERNIO PALA TIPO "A"

Flag Hinge model "A"
Paumelle á pelle modéle "A"



REF. PULIDA	REF. CINCADA	A	B	C	D	ØE	F		⊞	€/UD. PULIDA	€/UD. CINCADA
401P	4001	100	22	49	20	12	4		40	3,401 €	3,635 €
402P	4002	120	22	59	20	12	4		40	3,768 €	3,999 €
403P	4003	140	22	69	20	12	4		30	3,903 €	4,180 €
401RP	4001R	106	22	49	20	12	4	RODAMIENTO AXIAL	40	4,068 €	4,239 €
402RP	4002R	126	22	59	20	12	4	RODAMIENTO AXIAL	40	4,376 €	4,608 €
403RP	4003R	146	22	69	20	12	4	RODAMIENTO AXIAL	30	4,671 €	4,787 €

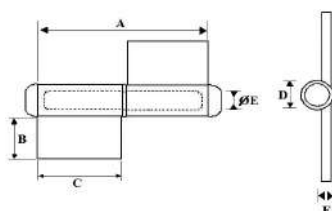

PERNOS/ FLAG/ PAUMELLE

PERNIO PALA TIPO "E"

Flag Hinge model "E"
Paumelle á pelle modéle "E"

REF. PULIDA	REF. CINCADA	A	B	ØC	D	E	ØF	G		📦	€/UD. PULIDA	€/UD. CINCADA
501P	5001	45	100	12	112	4	20	45		40	3,639 €	3,976 €
502P	5002	60	120	12	112	4	20	45		40	4,216 €	4,373 €
503P	5003	68	140	12	112	4	20	45		30	4,513 €	4,658 €
501RP	5001R	45	106	12	112	4	20	45	RODAMIENTO AXIAL	40	4,428 €	4,590 €
502RP	5002R	60	126	12	112	4	20	45	RODAMIENTO AXIAL	40	4,823 €	4,980 €
503RP	5003R	68	146	12	112	4	20	45	RODAMIENTO AXIAL	30	5,118 €	5,249 €
5004P	5004	45	140	12	112	4	20	45	3 CUERPOS	30	5,183 €	5,264 €

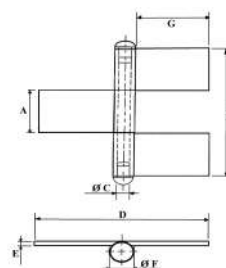
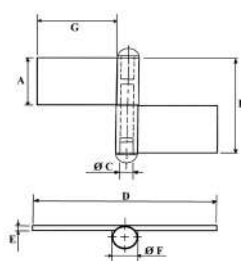

REFERENCIA	MEDIDA	A	B	ØD		📦	€/UD.
1010	10x60	60	28	10		60	0,637 €
1022	12x70	70	34	12		45	0,810 €
1016	14x80	79	38	14		28	0,931 €
O121	14x100	98	49	14		24	1,115 €
1014	16x100	98	49	16	CON ENGRASADOR	35	1,384 €
1019	18x120	118	58	18	CON ENGRASADOR	24	1,695 €
1006	20x120	118	58	20	CON ENGRASADOR	20	2,135 €
10011	25x120	118	58	25	CON ENGRASADOR	9	7,626 €
1015	30x120	118	58	30	CON ENGRASADOR	6	9,325 €

PERNO TORNEADO CON ARANDELA DE LATÓN

Hinge with brass washer
Paumelle avec rondelle en laiton

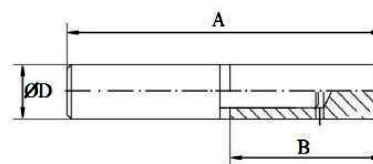

PERNO ARTÍSTICO

Artistic hinge
Paumelle artistique

REF. PULIDA	REF. CINCADA	MEDIDA	A	B	ØD	C		UD. CAJA	€/UD. PULIDA	€/UD. CINCADA
1021P	1021	16x100	99	49	16			75	2,652 €	2,920 €
107P	1007	20x120	118	58	20			50	2,721 €	3,249 €
* 101P	* 1001	20x130	125	58	20		RODAMIENTO AXIAL	50	5,377 €	5,927 €
108P	1008	20x170	165	58	20	45	TRES CUERPOS	50	3,929 €	4,376 €
109P	1009	20x150	150	73	20			30	3,184 €	3,514 €

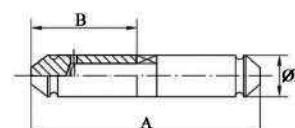
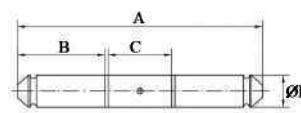

REF. PULIDA	REF. CINCADA	MEDIDA	A	B	ØD	RODAMIENTO	📦	€/UD. PULIDA	€/UD. CINCADA
102P	1002	20x130	127	59	20	AXIAL	20	3,421 €	4,372€
103P	1003	25x130	130	60	25	AXIAL	9	9,680 €	11,982 €
104P	1004	30x120	120	57	30	AXIAL	6	13,848 €	14,554 €
100P	1000	30x150	150	70	30	AXIAL	9	15,142 €	16,022 €
105P	1005	35x150	150	70	35	AXIAL	9	15,339 €	17,134 €
106P	106G	40x200	200	93	40	AXIAL	4	29,498 €	31,882 €
107P	107G	50x250	250	115	50	AXIAL	4	52,511 €	53,761 €

PERNO TORNEADO CON RODAMIENTO AXIAL

Hinge with axial bearing
Paumelle avec roulement axial

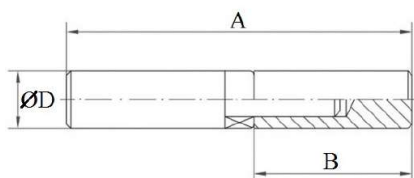

PERNO TORNEADO CON DOBLE RODAMIENTO AXIAL

Hinge with axial bearing
Paumelle avec roulement axial



REF. PULIDA	REF. CINCADA	MEDIDA	A	B	ØD	RODAMIENTO	📦	€/UD. PULIDA	€/UD. CINCADA
103PDR	1003DR	25x130	130	59	25	AXIAL	9	12,484 €	13,665€
100PDR	1000DR	30x150	150	60	30	AXIAL	9	17,984 €	19,261 €
105PDR	1005DR	35x150	150	57	35	AXIAL	9	18,665 €	19,886 €
106PDR	106GDR	40x200	200	93	40	AXIAL	4	56,889 €	60,511 €

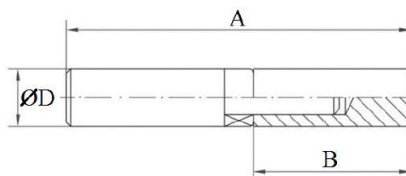

PASADOR CUADRADO 14 m/m

14 m/m squared barrel bolt
Verrou carré avec ressort 14 m/m

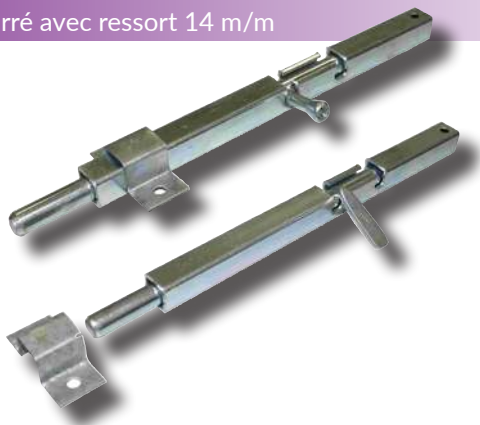

REF. NORMAL	REF. CODENA	MEDIDA	A	📦	€/UD.
01112	01113	120 mm	120	12	3,512 €
01100	02101	150 mm	150	12	3,231 €
01101	01201	200 mm	200	12	3,332 €
02201	02221	250 mm	250	12	3,515 €
01102	01202	300 mm	300	12	3,709 €
01103	01203	400 mm	400	12	4,481 €
01104	01204	500 mm	500	12	5,193 €

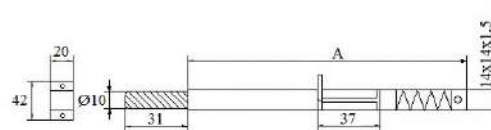

PASADOR CUADRADO / SQUARED BOLT / VERROU CARRÉ

REF. NORMAL	REF. CODENA	MEDIDA	A	📦	€/UD.
01000	01111	150 mm	150	10	3,303 €
01001	02001	200 mm	200	10	3,545 €
01105	01205	250 mm	250	10	3,614 €
01002	02002	300 mm	300	10	3,841 €
01003	02003	400 mm	400	10	4,574 €
01004	02004	500 mm	500	10	5,412 €
01005	02005	600 mm	600	10	6,223 €
01006	02006	800 mm	800	10	7,348 €
01007	02007	1000 mm	1000	10	8,007 €

PASADOR CUADRADO 16 m/m

16 m/m squared barrel bolt
Verrou carré avec ressort 16 m/m

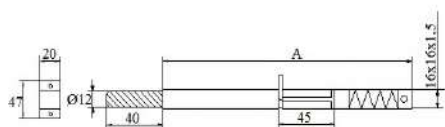

PASADOR CUADRADO CON MUELLE / SQUARED BARREL BOLT / VERROU CARRÉ AVEC RESSORT

PASADOR CUADRADO ATORNILLAR 16 m/m

16 m/m screw squared barrel bolt
Verrou visser carré avec ressort 16 m/m

REF. NORMAL	REF. CODENA	MEDIDA	A	📦	€/UD.
01001AT	02001AT	200 mm	200	10	3,789 €
01105AT	01205AT	250 mm	250	10	3,865 €
01002AT	02002AT	300 mm	300	10	4,096 €
01003AT	02003AT	400 mm	400	10	4,884 €

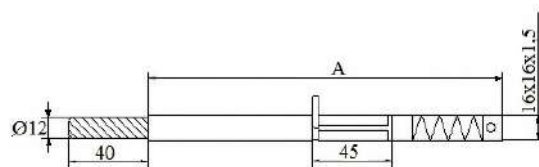

REF. NORMAL	REF. CODENA	MEDIDA	📦	€/UD.
03102A	03103A	250 mm	25	5,363 €

PASADOR CORTO ATORNILLAR Mod. B-16 16 m/m

16 m/m short bolt to screw model B
Verrou court à visser modèle B 16 m/m

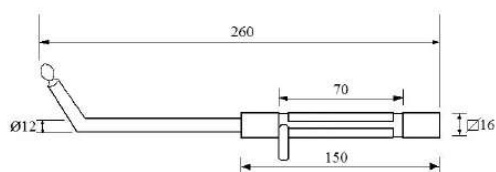

PASADOR LARGO ATORNILLAR Mod. B-16 16 m/m

16 m/m long bolt to screw model B-16
Verrou long à visser modèle B-16 16 m/m



REF. NORMAL	REF. CODENA	MEDIDA	A	📦	€/UD.
03001A	04001A	400 mm	370	30	6,214 €
03002A	04002A	500 mm	470	30	7,215 €
03003A	04003A	600 mm	570	30	8,173 €
03005A	04005A	800 mm	770	10	9,876 €
03006A	04006A	1000 mm	970	10	11,300 €

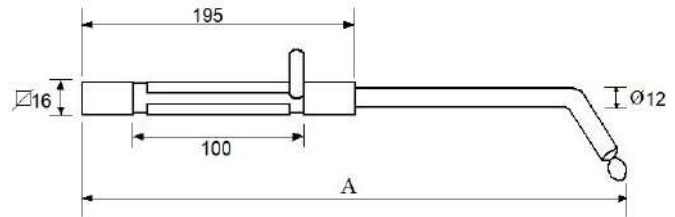

PASADOR LARGO ATORNILLAR Mod. B-20 20 m/m

20 m/m long bolt to screw model B-20
Verrou long à visser modèle B-20 20 m/m



REF. NORMAL	REF. CODENA	MEDIDA	A	📦	€/UD.
04101A	04201A	400 mm	370	20	8,964 €
04102A	04202A	500 mm	470	20	10,019 €
04103A	04203A	600 mm	570	20	10,330 €
04104A	04204A	700 mm	670	10	11,345 €
04105A	04205A	800 mm	770	10	11,920 €
04106A	04206A	1000 mm	970	10	13,154 €

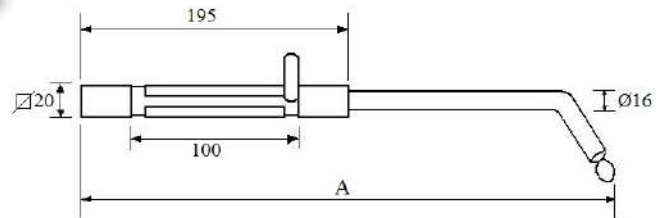

REF. NORMAL	REF. CODENA	MEDIDA	A	📦	€/UD.
03001	04001	400 mm	370	30	5,704 €
03002	04002	500 mm	470	30	6,620 €
03003	04003	600 mm	570	30	7,501 €
03005	04005	800 mm	770	10	9,065 €
03006	04006	1000 mm	970	10	10,372 €

PASADOR LARGO SOLDAR Mod. B-16 16 m/m

16 m/m long to weld
Verrou long à souder 16 m/m

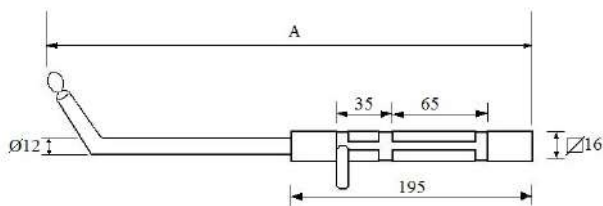

PASADOR SOLDAR CORTO Mod. B-16 16 m/m

16 m/m Deadbolt to weld model B
Verrou avec sécurité modèle B 16 m/m

REF. NORMAL	REF. CODENA	MEDIDA	📦	€/UD.
03102	03103	250 mm	25	4,922 €

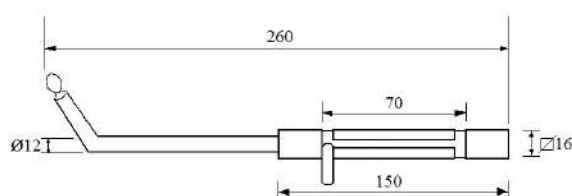

REF. NORMAL	REF. CODENA	MEDIDA	A	📦	€/UD.
04101	04201	400 mm	370	20	8,229 €
04102	04202	500 mm	470	20	9,190 €
04103	04203	600 mm	570	20	9,483 €
04104	04204	700 mm	670	10	10,415 €
04105	04205	800 mm	770	10	10,939 €
04106	04206	1000 mm	970	10	12,073 €

PASADOR LARGO SOLDAR Mod. B-20 20 m/m

20 m/m long bolt to weld model B-20
Verrou long à souder modèle B-20 20 m/m

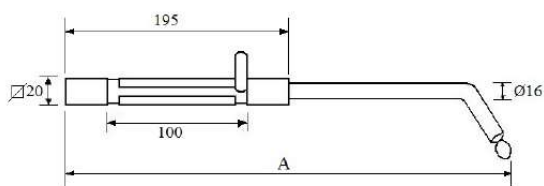

REF. NORMAL	REF. CONDENA	MEDIDA	A	📦	€/UD.
61000	400 mm	370	25	30	9,474 €
61001	500 mm	470	25	30	9,668 €
61002	600 mm	570	25	30	9,882 €

PASADOR LARGO REGULABLE SOLDAR 20 m/m

20 m/m long adjustable bolt to weld
Verrou long réglable à souder 20 m/m

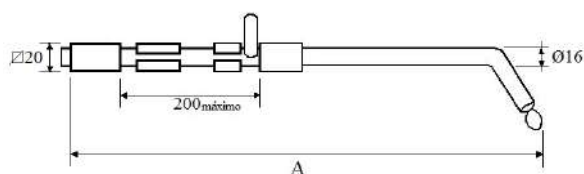
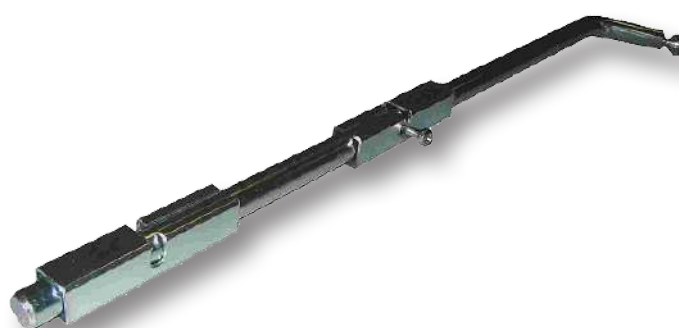

PASADOR LARGO REGULABLE ATORNILLAR 16 m/m

16 m/m long adjustable bolt to screw
Verrou long réglable à visser 16 m/m

REFERENCIA	MEDIDA	A	📦	€/UD.
61000A	400 mm	370	25	9,255 €
61001A	500 mm	470	25	9,679 €
61002A	600 mm	570	25	9,882 €

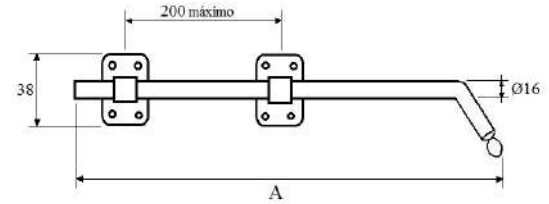

REFERENCIA	MEDIDA	A	B	C	Ø	📦	€/UD.
07001	200 mm	210	70	16	12	30	6,430 €
07003	270 mm	290	100	20	16	30	8,244 €

PASADOR Mod. CAL CON TALADRO PARA CANDADO

16/20 m/m long bolt with hole for lock
Verrou long avec trou cadenas 16/20m m/m

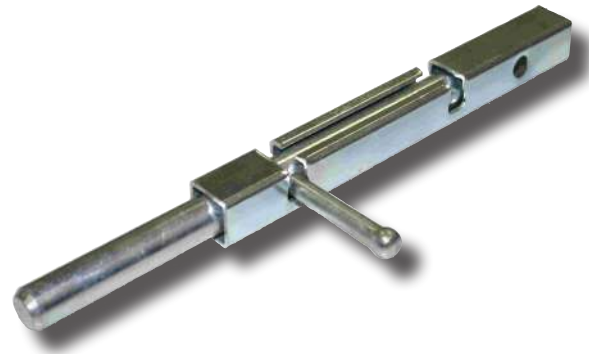
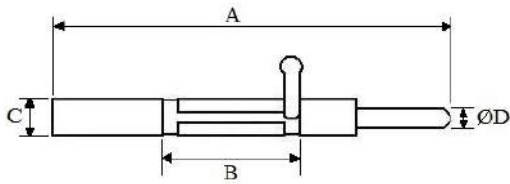

PASADOR LARGO SOLDAR RECTO 16 m/m

16 m/m long bolt straight
Verrou long a souder droit

REF. NORMAL	REF. CODENA	MEDIDA	A	📦	€/UD.
05001	06001	400 mm	390	10	6,138 €
05002	06002	500 mm	490	10	7,036 €
05003	06003	600 mm	590	10	8,089 €

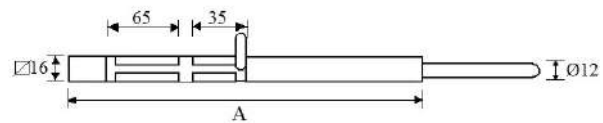

REF. NORMAL	REF. CODENA	A		€/UD.
61002E	62002E	570	30	11,401 €

PASADOR LARGO ESPECIAL SOLDAR 20 m/m

20 m/m long especial bolt to weld
Verrou long especial à souder 20 m/m

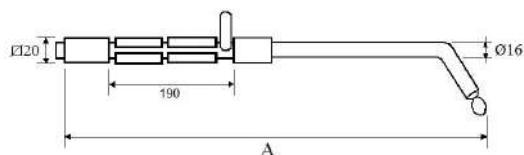

PASADOR LARGO ESPECIAL SOLDAR 16 m/m

16 m/m long especial bolt to weld
Verrou long especial à souder 16 m/m

REF. NORMAL	REF. CODENA	A		€/UD.
51002E	52002E	570	30	10,351 €

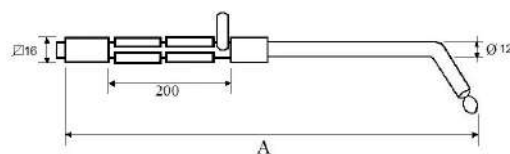

REFERENCIA	DESCRIPCIÓN	CAJA	€/UD.
PASE016	SIMPLE ACCIÓN 16	10	3,999 €
PASE024	SIMPLE ACCIÓN 24	10	5,558 €
PASED024	DOBLE ACCIÓN 200X24	10	6,322 €
TERM8R	TERMINAL VARILLA ROSCADA M-8	1	2,134 €
VARM8	VARILLA 7X400XM-8	1	2,250 €

PASADOR DE EMBUTIR

Flush bolt
Verrour à levier



POLEA / PULLEY / POULIE

REFERENCIA	DESCRIPCIÓN	A	B	Ø	MÉTRICA	📦	€/UD.
PC6010	60x10	58	17	10	16	30	5,833 €
PC8010	80x10	78	17	10	16	30	6,983 €
PC1010	100x10	98	17	10	16	24	8,424 €
PC1210	120x10	118	17	10	16	20	9,402 €
PC1510	150x10	147	17	10	16	10	14,587 €

POLEA CANAL 10 m/m

10 m/m groove wheel
Roue cannelure 10 mm

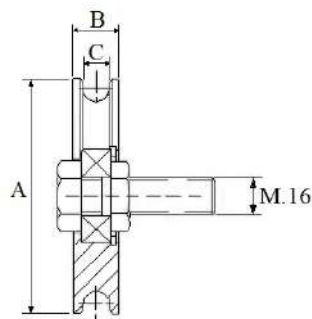

POLEA CANAL 10 m/m NYLON

10 m/m groove wheel
Roue cannelure 10 mm

REFERENCIA	DESCRIPCIÓN	A	B	C	MÉTRICA	📦	€/UD.
PC4510N	45x10	45	17	10	8	30	5,523 €
PC8010N	60x10	58	17	10	8	30	5,766 €
PC1010N	80x10	78	17	10	16	30	6,917 €
PC1210N	100x10	98	17	10	16	24	8,343 €
PC1210N	120x10	118	17	10	16	20	9,312 €
PC1210N	150x10	147	17	10	16	10	14,449 €

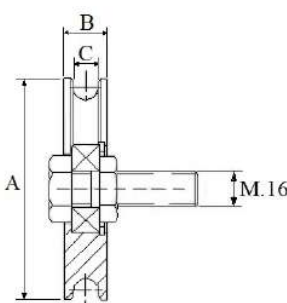

REFERENCIA	DESCRIPCIÓN	A	B	ØC	MÉTRICA	📦	€/UD.
U60M16	U60	15	34	52	Metrica 16	12	7,884 €
U80M16	U80	17	34	69	Metrica 16	12	11,411 €
UPN80M16	U80	17	34	62	Metrica 16	12	11,842 €

RODILLO GUIA

Guide roller
Coussinet guide

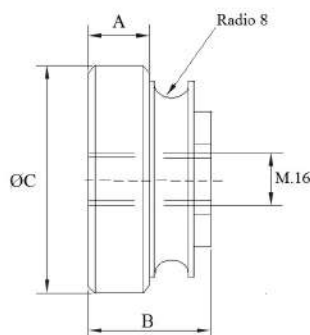

BISAGRA ANGULO SUPERIOR

Hinge for upper angle
Charnière pour angle supérieur

REF. PULIDA	REF. CINCADA	DESCRIPCIÓN	📦	€/UD. PULIDA	€/UD. CINCADA
P64040	P64040G	40x40	12	8,178 €	9,927 €

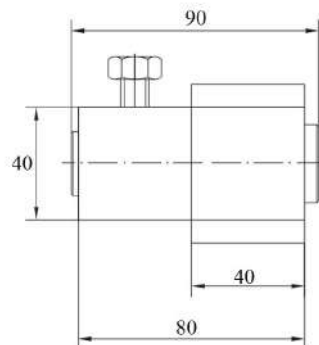
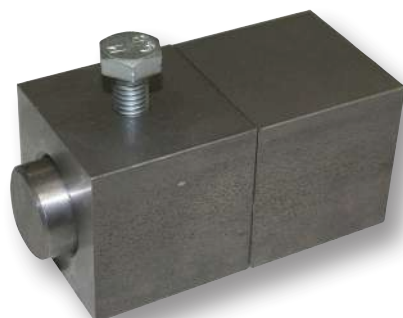

REFERENCIA	MED. /DIMENS.	📦	€/UD.
ANTIU60	U60	1	48,245 €
ANTIU80	U80	1	53,868 €
ANTIU100	U100	1	69,459 €
ANTIUPN80	UPN80	1	56,841 €
ANTIUPN100	UPN100	1	70,872 €

ANTICAIDAS P. BASCULANTES

Safety brakes
Freins de sécurité

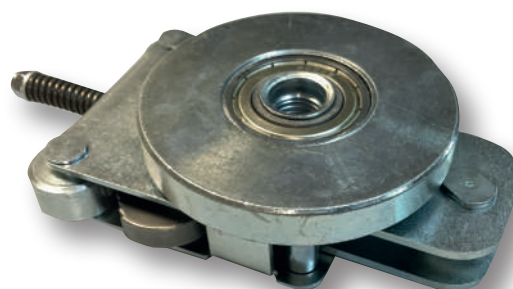

VARIOS / VARIOUS / VARIÉ

PROTECTOR BOMBILLO

Protection cylinder
Protection trou de serrure

REFERENCIA	A	FORMA	📦 CAJA	€/UD.
B5305P	5	PERA	50	1,448 €
B5305R	5	REDONDO	50	1,448 €
B5335P	10	PERA	50	1,448 €
B5335R	10	REDONDO	50	1,448 €

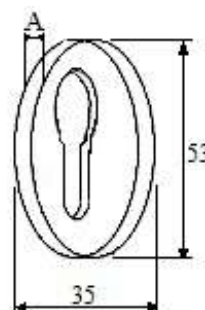

TIRADOR ENCASTAR

Built-in Handle
Poignée intégrée

NEW

REFERENCIA	DESCRIPCIÓN	ACABADO	📦	€/UD
485/P	MEDIANO	CINCADO	10	5,15 €
485/G	GRANDE	CINCADO	10	7,35 €

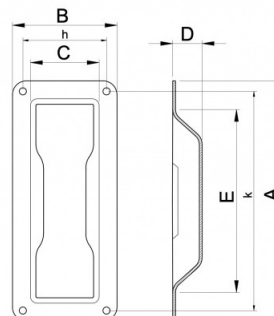

Art.	485P	485G
A	175	200
B	76	90
D	21	21
E	145	165
h	64	74
k	155	184

REFERENCIA	DESCRIPCIÓN	ACABADO	📦	€/UD
TC180N	180 mm	LACADO NEGRO	5	12,10 €
TC280N	280 mm	LACADO NEGRO	5	15,05 €

TIRADOR PARA CANCELTA CORREDERA - TIPO RECTO

Handle for sliding gate - Straight type
Poignée pour portatil coulissant - Type droit

NEW



REFERENCIA	DESCRIPCIÓN	A	B	C	ACABADO	📦	€/UD.
ASA100Z	100x27	107	27	65	CINCADO	30	1,286 €
ASA125Z	125x27	127	27	85	CINCADO	30	1,572 €
ASA100B	100x27	107	27	65	BICROMATADO	30	1,286 €
ASA125B	125x27	127	27	85	BICROMATADO	30	1,572 €
ASA100N	100x27	107	27	65	LACADO NEGRO	30	2,548 €
ASA125N	125x27	127	27	85	LACADO NEGRO	30	3,051 €

TIRADOR ASA ABATIBLE

Folding handle
Poignée á abatants

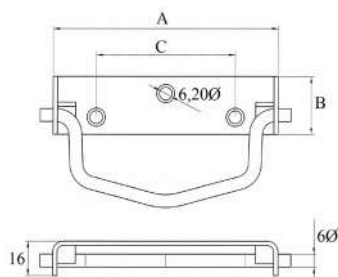

CIERRA PUERTAS HIDRAULICO FUERZA AJUSTABLE 2-4

Hydraulic door close adjustable force 2-4

Fermeture porte hydraulique force réglable 2-4



REFERENCIA	DESCRIPCIÓN	ACABADO	📦	€/UD
MCN01SR	SIN RETENEDOR	LACADO NEGRO	1	45,15 €
MCN02CR	CON RETENEDOR	LACADO NEGRO	1	45,90 €
MCP01SR	SIN RETENEDOR	PLATA	1	45,15 €
MCP02CR	CON RETENEDOR	PLATA	1	45,90 €



ROSETA

Rose
Rosette

REFERENCIA	ACABADO	📦	€/UD.
1101	CINCADO	500	0,365 €

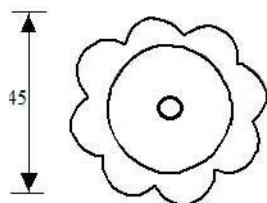

TIRADOR PERSIANA

Blind puller
Poignée store

REFERENCIA	DESCRIPCIÓN	ACABADO	📦	€/UD.
TP18100	18x100	CINCADO	50	2,473 €

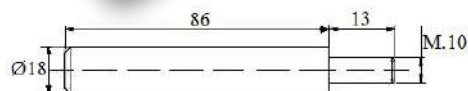

CERROJO COLA DE RATÓN Y SERRADERO

Bolt with mouse tail and bridge of bolt

Verrou avec la queue de la souris et pont à verrou

REFERENCIA	ACABADO	📦	€/UD
CR265	HIERRO	25	3,008 €
CR270	HIERRO	25	0,751 €

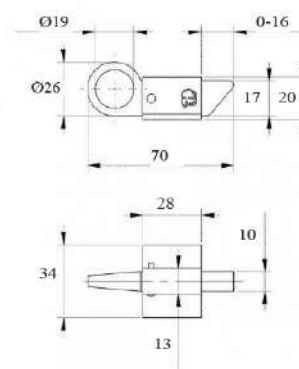

REFERENCIA	DESCRIPCIÓN	ACABADO	📦	€/UD.
1201	120x3,5	PULIDA	300	0,747 €

PUNTA DE LANZA

Top of lance
Pointe de lance

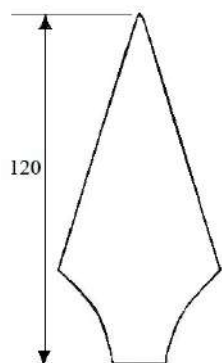

PESTILLERA PARA CERROJO

Hole bolt
Trou verrou

REFERENCIA	DESCRIPCIÓN	Ø	ACABADO	📦 CAJA	€/UD.
P0010	Vástago 10	10,25	CINCADO	100	1,621 €
P0012	Vástago 12	12,25	CINCADO	100	1,621 €

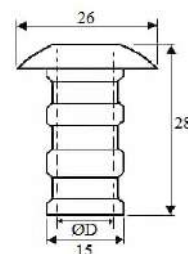

Ref. PULIDA	Ref. CINCADA	UD. CAJA	📦	€/UD. PULIDA	€/UD. CINCADA
061001	061001G	500	50	0,150 €	0,160 €

RINCONERA PARA JUNQUILLO

Corner glazing bead
Encoignure pour jonquille

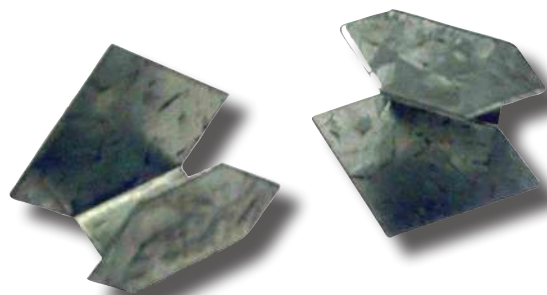
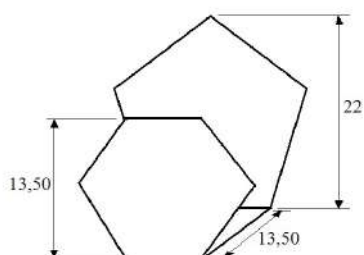

RUEDA / WHEEL / ROUE.

RUEDA CANAL 20/16 m/m INOX

20/16 mm Groove wheel Inox
Roue cannelure 20/16 m/mm Inox

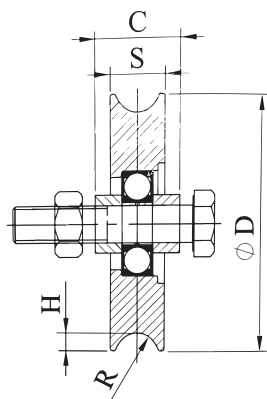

REFERENCIA	Ø	C	H	S	R	kg	📦	€/UD.
R16R060TX	60	33	9	23	16	400	24	20,991 €
R16R080TX	80	33	9	23	16	600	24	31,963 €
R16R090TX	90	33	9	23	16	600	24	41,198 €
R16R100TX	100	33	9	23	16	600	24	42,895 €
RER060TX	60	33	9	23	20	400	24	20,991 €
RER080TX	80	33	9	23	20	600	24	31,963 €
RER090TX	90	33	9	23	20	600	24	41,198 €
RER100TX	100	33	9	23	20	600	24	42,895 €
RER120TX	120	33	9	23	20	600	12	65,032 €

REFERENCIA	Ø	C	H	S	kg	📦	€/UD.
REV060TX	60	33	8	23	400	24	20,991 €
REV080TX	80	33	8	23	600	24	31,963 €
REV090TX	90	33	8	23	600	24	41,198 €
REV100TX	100	33	8	23	600	24	42,895 €
REV120TX	120	33	8	23	600	12	65,032 €

RUEDA CANAL ÁNGULO "V" INOX

V groove wheel Inox
Roue cannelure V Inox

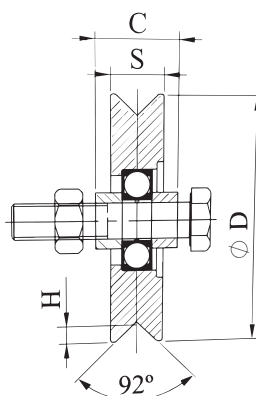

RUEDA CANAL 20/16 m/m SOLDAR INOX

20/16 mm Groove wheel box to weld Inox
Roue cannelure 20/16 m/mm avec support á souder Inox

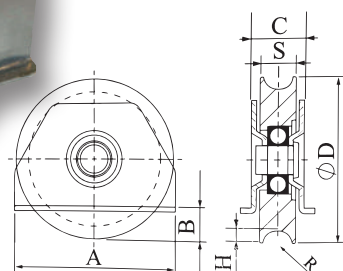

REFERENCIA	Ø	C	H	S	R	A	B	kg	📦	€/UD.
R16R060SX	60	33	9	23	16	62	10	400	24	28,383 €
R16R080SX	80	33	9	23	16	90	11	600	24	45,310 €
R16R090SX	90	33	9	23	16	90	17	600	24	58,126 €
R16R100SX	100	33	9	23	16	90	22	600	24	60,727 €
RER060SX	60	33	9	23	20	62	10	400	24	28,383 €
RER080SX	80	33	9	23	20	90	11	600	24	45,310 €
RER090SX	90	33	9	23	20	90	17	600	24	58,126 €
RER100SX	100	33	9	23	20	90	22	600	24	60,727 €
RER120SX	120	33	9	23	20	130	15	600	12	77,247 €

RUEDA / WHEEL / ROUE.

REFERENCIA	Ø	C	H	S	A	B	kg	📦	€/UD.
REV060SX	60	33	8	23	62	10	400	24	28,383 €
REV080SX	80	33	8	23	90	11	600	24	45,310 €
REV090SX	90	33	8	23	90	17	600	24	58,126 €
REV100SX	100	33	8	23	90	22	600	24	60,727 €
REV120SX	120	33	8	23	130	15	600	12	77,247 €

RUEDA CANAL ANGULO "V" SOLDAR INOX

V groove wheel box to weld Inox
Roue V avec support à souder Inox

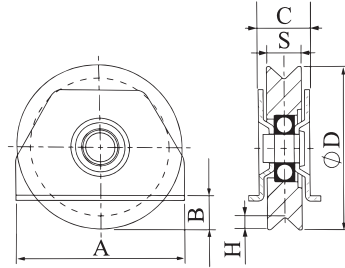

RUEDA CANAL 20/16 m/m ATORNILLAR INOX

20/16 mm groove wheel box to fit Inox
Roue cannelure 20/16 m/mm fit support à encastrer Inox

REFERENCIA	Ø	C	H	S	R	A	B	E	ØF	G	kg	📦	€/UD.
R16R080X	80	33	9	23	16	150	30	125	9	15	600	24	33,592 €
R16R090X	90	33	9	23	16	150	35	125	9	15	600	24	46,160 €
R16R100X	100	33	9	23	16	150	40	125	9	15	600	24	46,264 €
RER080X	80	33	9	23	20	150	30	125	9	15	600	24	33,592 €
RER090X	90	33	9	23	20	150	35	125	9	15	600	24	46,160 €
RER100X	100	33	9	23	20	150	40	125	9	15	600	24	46,264 €
RER120X	120	33	9	23	20	200	40	180	9	20	600	12	69,312 €

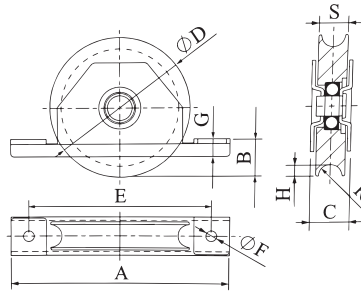

REFERENCIA	Ø	C	H	S	A	B	E	ØF	G	kg	📦	€/UD.
REV080X	80	33	8	23	150	30	125	9	15	600	24	33,592 €
REV090X	90	33	8	23	150	35	125	9	15	600	24	46,160 €
REV100X	100	33	8	23	150	40	125	9	15	600	24	46,264 €
REV120X	120	33	8	23	200	40	180	9	20	600	12	69,312 €

RUEDA CANAL ANGULO "V" ATORNILLAR INOX

V groove wheel box to fit Inox
Roue c. V avec support à encastrer Inox

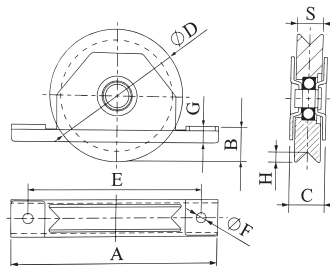

**RUEDA NYLON CANAL 20 m/m
ATORNILLAR INOX**

20 m/m nylon wheel with box to fit Inox
R.20 nylon avec support á encastrer Inox

REFERENCIA	Ø	C	H	S	R	A	B	E	ØF	G			€/UD.
RER080NX	80	33	9	23	20	150	30	125	9	15	600	12	23,060 €
RER100NX	100	33	9	23	20	150	40	125	9	15	600	12	30,820 €
RER120NX	120	33	9	23	20	200	40	180	9	20	600	12	34,784 €

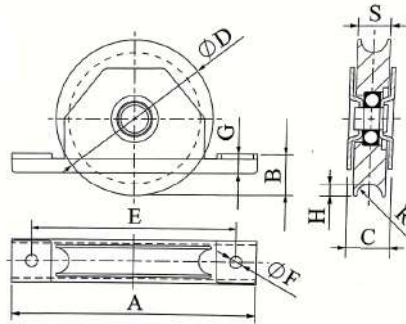
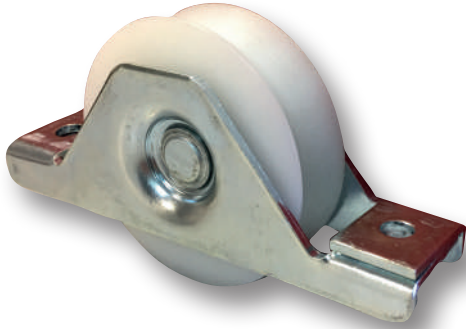

REFERENCIA	Ø	C	H	S	A	B	E	ØF	G			€/UD.
REV080NX	80	33	8	23	150	30	125	9	15	600	12	23,060 €
REV100NX	100	33	8	23	150	40	125	9	15	600	12	30,820 €
REV120NX	120	33	8	23	200	40	180	9	20	600	12	34,784 €

**RUEDA NYLON CANAL ÁNGULO "V"
ATORNILLAR INOX**

V nylon wheel with box to fit Inox
R.V nylon avec support á encastrer Inox

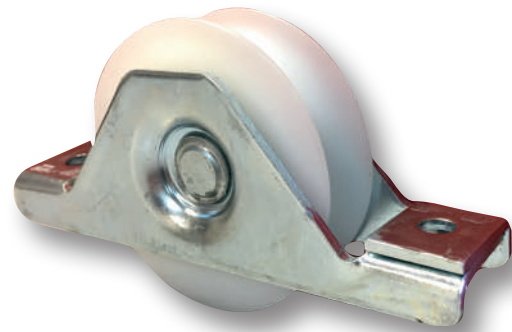
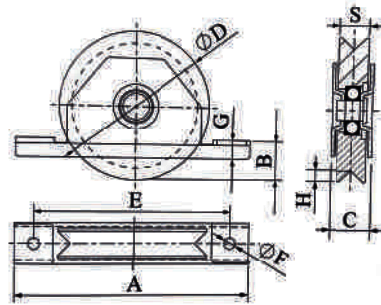

POLEA CANAL 10 m/m INOX

10 m/m groove wheel Inox
Roue cannelure 10 mm Inox

REFERENCIA	DESCRIPCIÓN	A	B	Ø	MÉTRICA		€/UD.
PC6010X	60x10	58	17	10	10	30	24,802 €
PC8010X	80x10	78	17	10	16	30	40,841 €
PC1010X	100x10	98	17	10	16	24	54,336 €
PC1210X	120x10	118	17	10	16	20	77,818 €

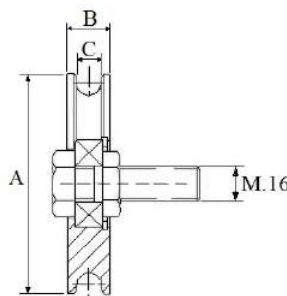

REFERENCIA	A	D	L	M	N		€/UD.
RG0030X	40	30	84	14	45	30	7,341 €
RG0040X	40	40	84	14	45	30	8,391 €
RG0060X	60	40	94	14	35	30	9,441 €
RG0035X	50	35	94	14	45	30	8,951 €
RG0050X	60	50	105	14	35	30	11,184 €

RODILLO NYLON INOX

Nylon roller Inox
Poulie guide en nylon Inox

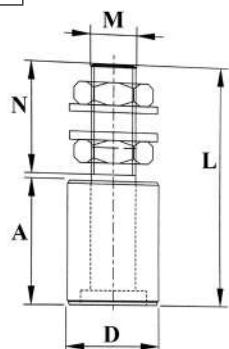

CAJA POLEAS GUÍA REGULABLE INOX

Plate top guide Inox
Plaque guide Inox

REFERENCIA	MED. /DIMENS.	A	B	C	E	F	L	S		€/UD.
CP0030SX	Simple	70	140	50	30	70		3	10	75,863 €
CP0030MX	Mediana	155	140	50	30	70	220	3	10	97,125 €

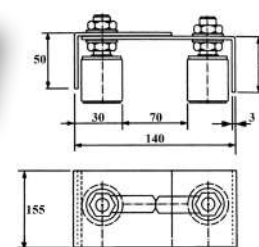
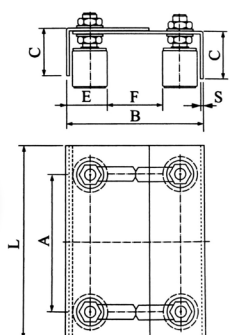

BISAGRA FIJA ESFÉRICA INOX

Spherica hinge inox
Paumelle esferica Inox

REFERENCIA	A	B	ØC	D	E	ØF	G		€/UNIDAD
2001X	38	80	10	95	2,5	16	39	75	10,289 €
2002X	48	100	10	95	2,5	16	39	75	12,204 €
2004X	38	119	10	95	2,5	16	39	50	19,314 €

* Tres cuerpos

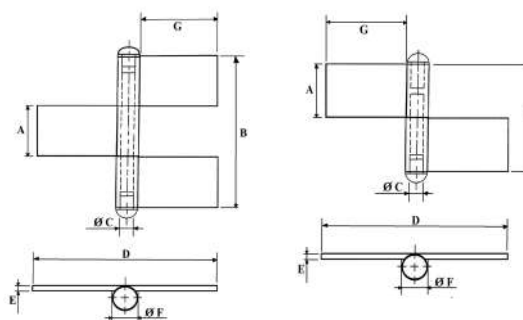
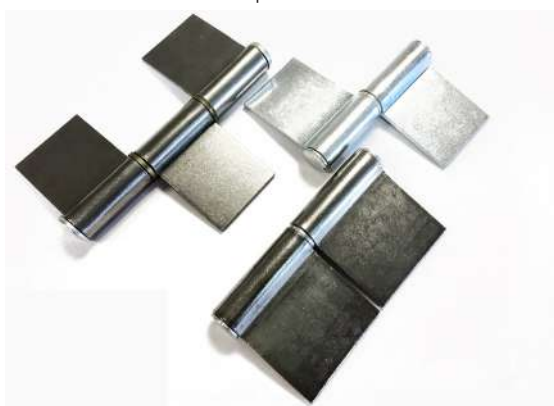

REFERENCIA	ACABADO	ØD x A	E	B	C	ØF	PALA	📦	€/UD.
7009XT	INOX CON TAPON	12 x 80	2	38	25	8	LARGA	20	4,207 €
7003XT	INOX CON TAPON	14 x 80	3	38	20	8	LARGA	20	4,668 €
7004XT	INOX CON TAPON	16 x 100	3	48	20	10	LARGA	10	5,363 €
7005XT	INOX CON TAPON	18 x 110	4	53	18	10	LARGA	10	6,057 €
7006XT	INOX CON TAPON	20 x 120	4	58	20	12	LARGA	10	9,444 €

PERNIO PALA INOX CON TAPON INOX

Flag hinge with stopper Inox
Paumelle á pelle avec bouchon Inox

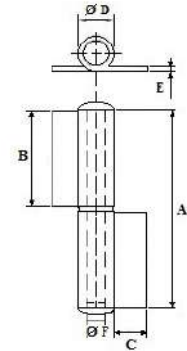

PERNIO PALA INOX SIN TAPON INOX

Flag hinge without stopper Inox
Paumelle á pelle sans bouchon Inox

REFERENCIA	ACABADO	ØD x A	E	B	C	ØF	PALA	📦	€/UD.
7009X	INOX SINTAPON	12 x 80	2	38	25	8	LARGA	20	3,826 €
7003X	INOX SINTAPON	14 x 80	3	38	20	8	LARGA	20	4,351 €
7004X	INOX SINTAPON	16 x 100	3	48	20	10	LARGA	10	4,992 €
7005X	INOX SINTAPON	18 x 110	4	53	18	10	LARGA	10	5,774 €
7006X	INOX SINTAPON	20 x 120	4	58	20	12	LARGA	10	9,026 €

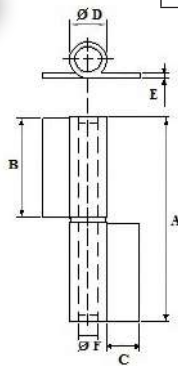

REF. NORMAL	MEDIDA	A	ACABADO	UD. CAJA	€/UD.
01000XA	15x15x150x1 mm	150	INOX	10	13,928 €
01001XA	15x15x200x1 mm	200	INOX	10	14,659 €
01105XA	15x15x250x1 mm	250	INOX	10	15,688 €
01002XA	15x15x300x1 mm	300	INOX	10	16,647 €
01003XA	15x15x400x1 mm	400	INOX	10	19,653 €
01004XA	15x15x500x1 mm	500	INOX	10	22,967 €

PASADOR CUADRADO NORM ATORNILLAR 15 m/m INOX

15 m/m norm. screw squared barrel bolt Inox
Verrou visser carré avec ressort 15m/m Inox

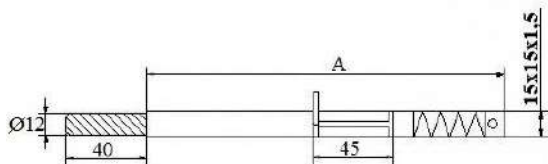

PASADOR CUADRADO COND. ATORNILLAR 15 m/m INOX

15 m/m Deadbolt squared barrel Inox
Verrou carré avec sécurité 15m/m Inox

REF. CONDENA	MEDIDA	A	ACABADO	UD. CAJA	€/UD.
01111XA	15x15x150x1 mm	150	INOX	10	13,928 €
02001XA	15x15x200x1 mm	200	INOX	10	14,659 €
01205XA	15x15x250x1 mm	250	INOX	10	15,688 €
02002XA	15x15x300x1 mm	300	INOX	10	16,647 €
02003XA	15x15x400x1 mm	400	INOX	10	19,653 €
02004XA	15x15x500x1 mm	500	INOX	10	22,967 €

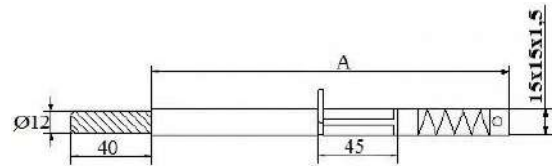

REF. NORMAL	MEDIDA	A	ACABADO	UD. CAJA	€/UD.
01000X	15x15x150x1 mm	150	INOX	10	12,664 €
01001X	15x15x200x1 mm	200	INOX	10	13,327 €
01105X	15x15x250x1 mm	250	INOX	10	14,261 €
01002X	15x15x300x1 mm	300	INOX	10	15,134 €
01003X	15x15x400x1 mm	400	INOX	10	17,861 €
01004X	15x15x500x1 mm	500	INOX	10	20,886 €

PASADOR CUADRADO NORM 15 m/m INOX

15 m/m norm. squared barrel bolt Inox
Verrou carré avec ressort 15m/m Inox

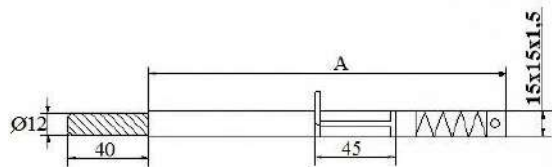

PASADOR CUADRADO COND. 15 m/m

15 m/m Deadbolt squared barrel inox
Verrou carré avec sécurité 15m/m inox

Ref. CON-DENA	MEDIDA	A	ACABADO	UD. CAJA	€/UD.
01111X	15x15x150x1 mm	150	INOX	10	12,664 €
02001X	15x15x200x1 mm	200	INOX	10	13,327 €
01205X	15x15x250x1 mm	250	INOX	10	14,261 €
02002X	15x15x300x1 mm	300	INOX	10	15,134 €
02003X	15x15x400x1 mm	400	INOX	10	17,861 €
02004X	15x15x500x1 mm	500	INOX	10	20,886 €

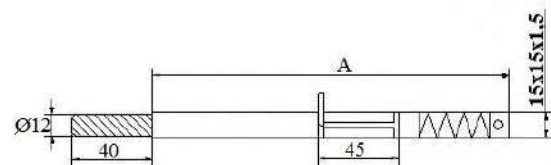

REFERENCIA	A	B	ØC	D	E		📦	€/UNIDAD
3001X	80	54	10	3	16		75	10,448 €
3002X	100	65	12	4	20		50	15,068 €
3003X	120	65	12	4	20		50	16,821 €
3001TX	80	54	10	3	16	TALADRADA	75	11,152 €
3002TX	100	65	12	4	20	TALADRADA	50	15,667 €
3003TX	120	65	12	4	20	TALADRADA	50	17,769 €

BISAGRA LIBRO INOX

Butt hinge Inox
Charnière livre Inox

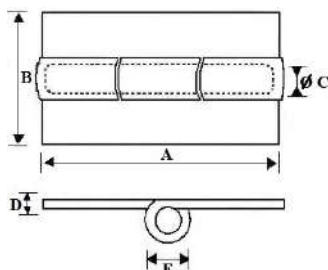

**PERNO TORNEADO
CON RODAMIENTO AXIAL INOX**

Floding handle Inox
Poignée á abatants Inox

REFERENCIA	DESCRIPCIÓN	A	B	ØD	RODAMIENTO	📦	€/UD.
1002X	20x130	127	59	20	INOX	10	16,25 €

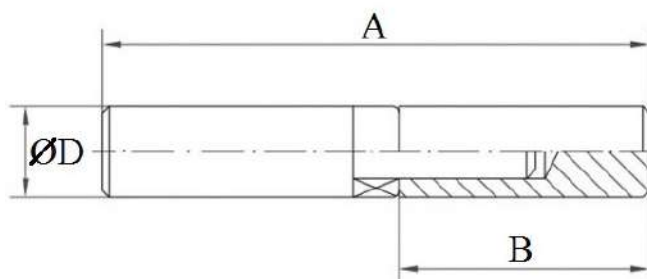

REFERENCIA	MEDIDA	A	B	ØD		📦	€/UD.
1016X	14x80	79	38	14	CON ENGRASADOR	10	4,253 €
1014X	16x100	98	49	16	CON ENGRASADOR	10	6,321 €
1006X	20x120	118	58	20	CON ENGRASADOR	10	8,495 €

PERNO TORNEADO INOX

Hinge Inox
Paumelle Inox

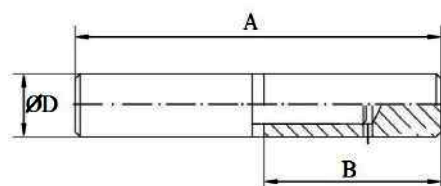

CONDICIONES GENERALES / GENERAL CONDITIONS / CONDITIONS GÉNÉRALES DE VENTE



CONDICIONES GENERALES DE VENTA

- Solo se aceptaran pedidos por escrito, vía email a facrisur@facrisur.es o por fax +34 955 631 036.
- Moneda: Euro (€).
- Los portes de los pedidos inferiores a 500€ correrán a cargo del cliente, cargándose siempre en factura.
- Solo vendemos cajas completas. Si las unidades pedidas no coinciden con nuestras unidades por caja se enviarán cajas completas.
- Todas las reclamaciones deberán ser realizadas en un periodo de 20 días desde la recepción de la mercancía.
- Toda devolución de material deberá de ser autorizada previamente por FACRISUR, S.L , siendo por cuenta del cliente cualquier gasto derivado de dicha devolución. No se aceptarán devoluciones de productos fabricados a medida , ni de productos fuera del catálogo.
- Estas condiciones de venta están reguladas por la ley doméstica Española. En caso de existir controversias en el contrato, las partes acudirán a arbitraje regulado por la Cámara de Comercio Internacional.
- Esta lista de precio anula las anteriores.
- Entrada en Vigor: 20-01-2021.
- Todos los pedidos requieren la aceptación de nuestras condiciones de venta.
- FACRISUR, S.L se reserva el derecho de modificar estas condiciones sin previo aviso.



GENERAL CONDITIONS

- We will only accept orders by to email facrisur@facrisur.es or by fax to: +34 955 631 036.
- Currency : Euro (€).
- The freightages they were negotiated according to zone of delivey and quantity.
- We only sell full packing boxes. If the quantities ordered are not in accordance with the units of our boxes, full boxes will be sent.
- All claims will have to be made within 20 days from the reception of the goods.
- All good´s returns must be previously approved by FACRISUR, S.L the customer will assume all cost arose in the return. We will not accept goodreturns of tailor made products or products that are out of our catalogue.
- These sales conditions are governed by the Spanish domestic law. In case of controversias arising from the contract the parties may agree to have disputes settled by arbitration taking place in international Chamber.
- This price list enters into force on the 20-01-2021.
- FACRISUR, S.L reserves the right to modify these conditions without any previous notice.



CONDITIONS GÉNÉRALES DE VENTE

- On acceptera seulement les commandes qui ont été envoyées por email á facrisur@facrisur.es, par fax au numéro +34 955 631 036.
- Monnaie: Euro(€).
- Les ports seront négociés selon une zone de livraison et de quantité.
- Les commandes seront toujours de boîtes complètes. Si les quantités commandées ne coincident pas avec nos unités par boîte, on livrera des boîtes complètes.
- On acceptera seulement les réclamations faites entre les 20 jours après la reception des marchandises.
- Tous les retours de marchandises doivent être autorisés au préalable par FACRISUR,S.L , étant tous les frais dérivés du retour au charge du client. On n´acceptera pas des retours de produits spéciaux ou hors de catalogue. Ces conditions sont réglées par la loi espagnole de commerce. En cas de controverse dans le contrat, les parties feront appel á l´arbitrage de la Chambre de Commerce Internationale.
- Toutes les commandes exigent accepter nos conditions de vente.
- Ce tarif annule les antérieurs.
- Ce tarif será en vigueur á partir de 20-01-2021.
- FACRISUR, S.L se réserve de droit de modifier ces conditions sans pré-avis.

Lined area for writing notes, consisting of multiple horizontal lines.



Handwriting practice area with 21 horizontal lines.





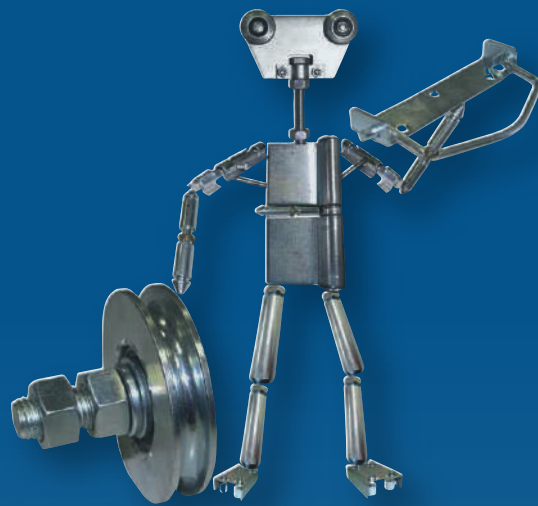

facrisur

Fabricación de herrajes para carpintería metálica

Polígono Industrial La Red
C/ La Red, nº 6, Parcela 50, Naves 19-20-21
41500 Alcalá de Guadaira - SEVILLA
Telf.: 955 63 08 08
facrisur@facrisur.es
www.facrisur.es

